



**2GR45AF KLEENSCREEN
FRYER BATTERY**

GRA SERIES GAS FRYERS WITH KLEENSCREEN PLUS® FILTRATION SYSTEMS

MODEL	ML	MODEL	ML
1GR45A	136647	3GR85AF	136655
1GR65A	136648	4GR45AF	136656
1GR85A	136649	4GR65AF	136657
2GR45AF	136650	4GR85AF	136681
2GR65AF	136651	2XGR45AF	136658
2GR85AF	136652	2XGR65AF	136659
3GR45AF	136653	2XGR85AF	136660
3GR65AF	136654		

This Manual is prepared for the use of trained Vulcan Service Technicians and should not be used by those not properly qualified.

This manual is not intended to be all encompassing. If you have not attended a Vulcan Service School for this product, you should read, in its entirety, the repair procedure you wish to perform to determine if you have the necessary tools, instruments and skills required to perform the procedure. Procedures for which you do not have the necessary tools, instruments and skills should be performed by a trained Vulcan Service Technician.

The reproduction, transfer, sale or other use of this Manual, without the express written consent of Vulcan, is prohibited.

This manual has been provided to you by ITW Food Equipment Group LLC ("ITW FEG") without charge and remains the property of ITW FEG, and by accepting this manual you agree that you will return it to ITW FEG promptly upon its request for such return at any time in the future.

For additional information on Vulcan-Hart Company or to locate an authorized parts and service provider in your area, visit our website at www.vulcanhart.com.

TABLE OF CONTENTS

GENERAL	3
Introduction	3
Single Floor Model Fryers	3
Kleenscreen Filtration System	4
Specifications	4
Electrical	4
Gas Pressures	4
Tools	4
REMOVAL AND REPLACEMENT OF PARTS	5
Splash Guard (Kleenscreen Fryers Only)	5
Cooking Controls	5
Discard Valve Switch (Kleenscreen Fryers Only)	5
Gas Burners	6
Gas Orifice	7
Gas Combination Valve	7
Gas Pilot	8
Temperature Probe	9
High Limit Thermostat	9
Power Supply Box Components	10
Fill Solenoid Valve (Kleenscreen Fryers Only)	11
Pump and Motor (Kleenscreen Fryers Only)	11
Fry Tank Assembly	12
SERVICE PROCEDURES AND ADJUSTMENTS	14
Temperature Probe Test	14
Cooking Control Calibration	15
Electronic Ignition System	15
Flame Sense Current Check	16
Electronic Ignition Control Test	16
Gas Manifold Pressure Adjustment	18
ELECTRICAL OPERATION	19
Component Function	19
Power Supply Box Components	21
Sequence of Operation	22
Kleenscreen Filtering System	23
Schematic Diagrams	24
Fryers Without Kleenscreen Filtration System	24
Fryers with Kleenscreen Filtration System	25
Wiring Diagrams	26
Frymate (Dump Station)	30
TROUBLESHOOTING	31
All Models	31
Ignition Module	32
Frymate (Dump Station) with Optional Heater	35
Kleenscreen Filtering System	36

GENERAL

INTRODUCTION

This Service Manual covers specific service information related to the models listed on the front cover. GRA series gas fryers come equipped with behind-the-door solid state controls. The features and operation of the cooking controls are the same for both single floor model fryers and kleenscreen battery fryers.

SINGLE FLOOR MODEL FRYERS

Fryers with the Filter-Ready option installed, use the Mobile Filter. For service information related to the Mobile filter refer to F24599 MOBILE FILTERS.

A GRO Frymate (dump station) can be configured in a battery with fryers 15 1/2 inches or 21 inches in width.

Model	NO. OF HEAT TUBES EACH FRY TANK	BTU/HOUR EACH FRY TANK	FRYER WIDTH (INCHES)	SHORTENING CAPACITY (LBS) EACH FRY TANK
1GR45A	4	120,000	15.5	45-50
1GR65A	5	150,000	21.0	65-70
1GR85A	5	150,000	21.0	85-90
2GR45AF	4	120,000	31.0	45-50
3GR45AF	4	120,000	46.5	45-50
4GR45AF	4	120,000	62.0	45-50
2GR65AF	5	150,000	42.0	65-70
3GR65AF	5	150,000	63.0	65-70
4GR65AF	5	150,000	84.0	65-70
2GR85AF	5	150,000	42.0	85-90
3GR85AF	5	150,000	63.0	85-90
4GR85AF	5	150,000	84.0	85-90
2XGR45AF	4	120,000	31.0	45-50
2XGR65AF	5	150,000	42.0	65-70
2XGR85AF	5	150,000	42.0	85-90

KLEENSCREEN FILTRATION SYSTEM

The Kleenscreen filtration system is integrated into the GRA Series fryer battery. The filter is housed in a pull-out drawer assembly at the base of the fryer. The filtering components in the drawer include a stainless steel filter tank, crumb-catch basket and a dual element mesh filter screen. With the filter drawer closed, a self-seating oil return line provides the path to return the filtered shortening to the fry tank.

This system is designed to provide a thorough and easy method to filter the shortening.

Some of the benefits include:

- Self-contained system eliminating the use of external filter equipment.
- Paperless filtering system.
- Easy to clean and low maintenance.

Kleenscreen fryer batteries are available in a minimum of two and a maximum of four fryer sections. The fryer size of each section is identical.

A GRO Frymate (dump station) can also be included as one or more of the sections.

SPECIFICATIONS

Electrical

- 120VAC supply. A 24VAC transformer provides power for the fryer controls and the filtering controls on Kleenscreen battery fryers.

Gas Pressures

Manifold (per fryer section):

- Natural - 4" W.C.
- Propane - 10" W.C.

Building supply pressure (Min):

- Natural - 5" W.C. (7" W.C. battery units)
- Propane - 11" W.C. (12" W.C. battery units)

NOTE: Propane or Natural gases -14" W.C. (Max)

TOOLS

Standard

- Standard set of hand tools.
- VOM with A/C current tester (any quality VOM with a sensitivity of at least 20,000 ohms per volt can be used).
- Temperature tester (thermocouple type).
- U-Tube Manometer.

Special

- Field service grounding kit (available locally)
- OnWatch QuickLook™ 72, checks flame sense and input voltage to the Honeywell S8600 series ignition control module with an EnviraCOM™ port.

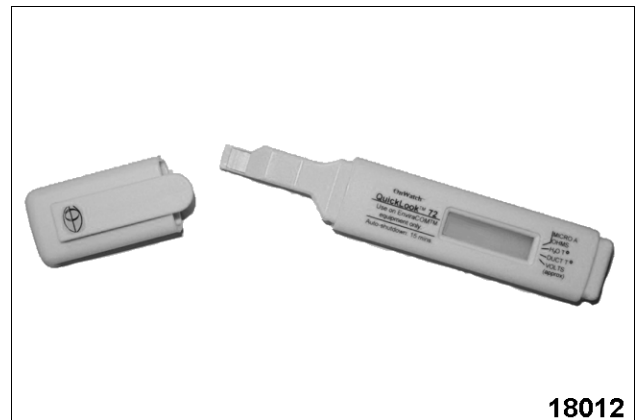

18012

You can order the QuickLook™ 72 on line at www.onwatchinc.com. The OnWatch Combo Item #721014 includes both the QuickLook™ 72 and a 3 ft. data port extension cable.

- Burndy pin extraction tool RX2025 GE1; Newark Electronics Catalog Number 16F6666. Used for removing pin terminals on Burndy connectors.

REMOVAL AND REPLACEMENT OF PARTS

SPLASH GUARD (KLEENSCREEN FRYERS ONLY)



⚠ WARNING Disconnect the electrical power to the machine and follow lockout / tagout procedures.

1. Open fryer section doors.
2. Remove screws securing splash guard.

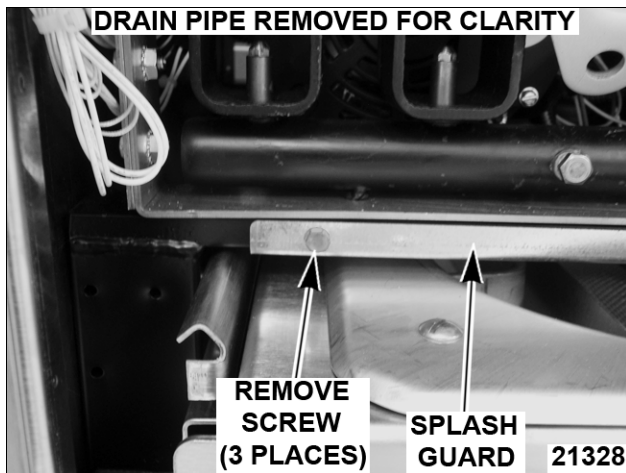

3. Remove splash guard.
4. Reverse procedure to install.

COOKING CONTROLS



⚠ WARNING Disconnect the electrical power to the machine and follow lockout / tagout procedures.

NOTICE Certain components in this system are subject to damage by electrostatic discharge during field repairs. A field service grounding kit is available to prevent damage. The field service grounding kit must be used anytime the control board is handled.

1. Open fryer section door(s).
2. Remove connections to cooking controls.

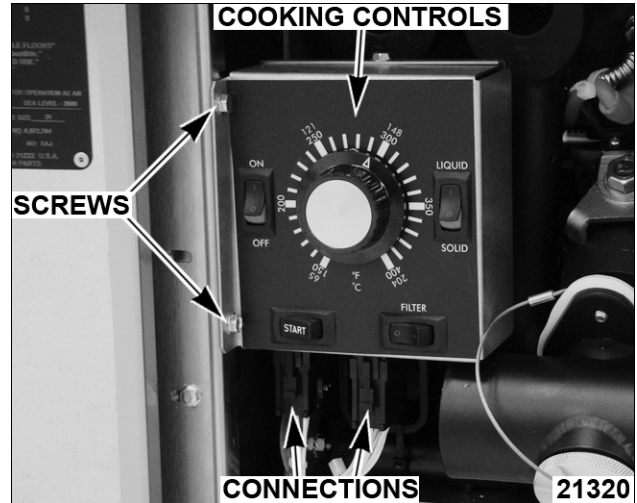

3. Remove screws securing controls.
4. Remove cooking controls.
5. Disconnect lead wires from the component being replaced then remove from control box.

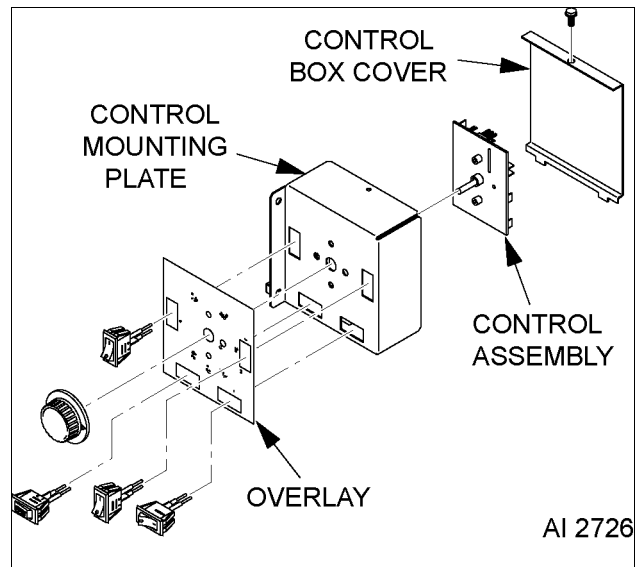

6. Reverse procedure to install and check for proper operation.

DISCARD VALVE SWITCH (KLEENSCREEN FRYERS ONLY)



⚠ WARNING Disconnect the electrical power to the machine and follow lockout / tagout procedures.

1. Open the fryer section doors above filter pan.

2. Pull filter drawer out, remove filter tank assembly and push the tank support arms back into place under the fryer.
3. Remove splash guard from base frame.

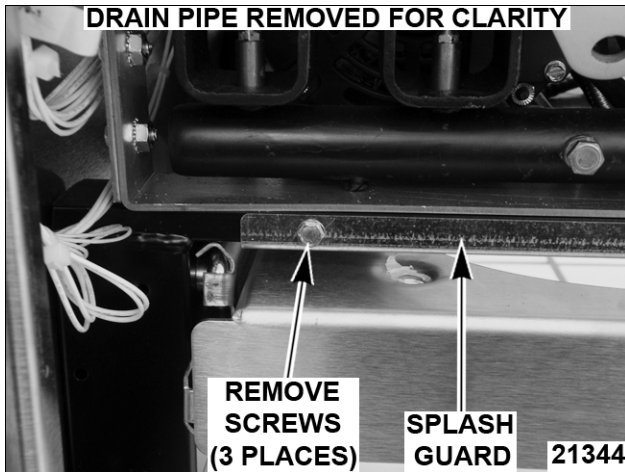

4. From underneath the fryer:
 - A. Disconnect the discard valve switch lead wire connector from power supply box.
 - B. Remove switch mounting screws.

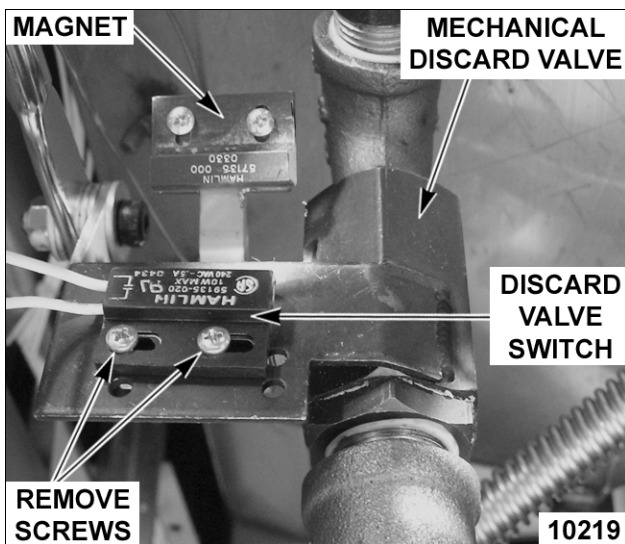

5. Reverse procedure to install and check for proper operation.

GAS BURNERS



⚠ WARNING Disconnect the electrical power to the machine and follow lockout / tagout procedures.

⚠ WARNING Shut off the gas before servicing the unit.

1. Open the door to the fryer section being serviced.

2. Remove cooking controls to access burner(s) if necessary.

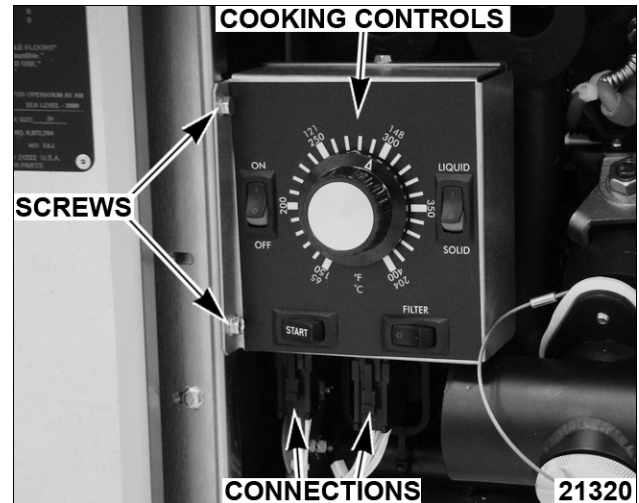

3. Remove drain pipe to access burner(s) if necessary.

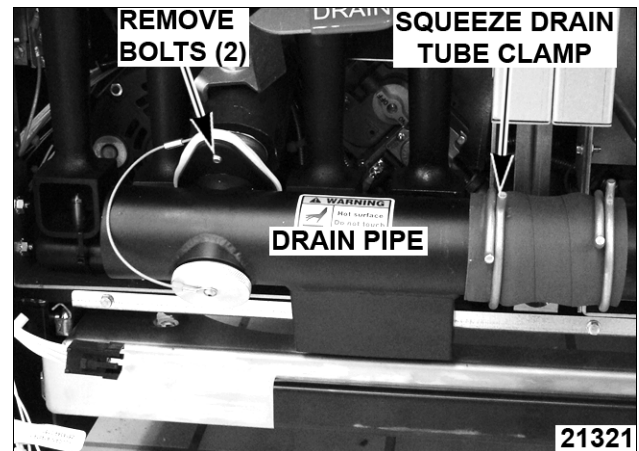

4. Remove gas burner shipping ties (if installed).

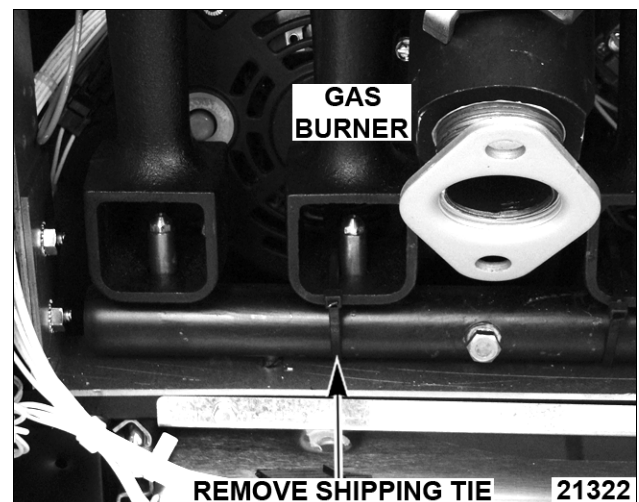

5. Lift gas burner up and tilt the top of burner toward fryer tank until it clears the gas orifice at the bottom.

NOTE: The burners mount to the burner mounting bracket by shoulder bolts that rest in the keyway slot.

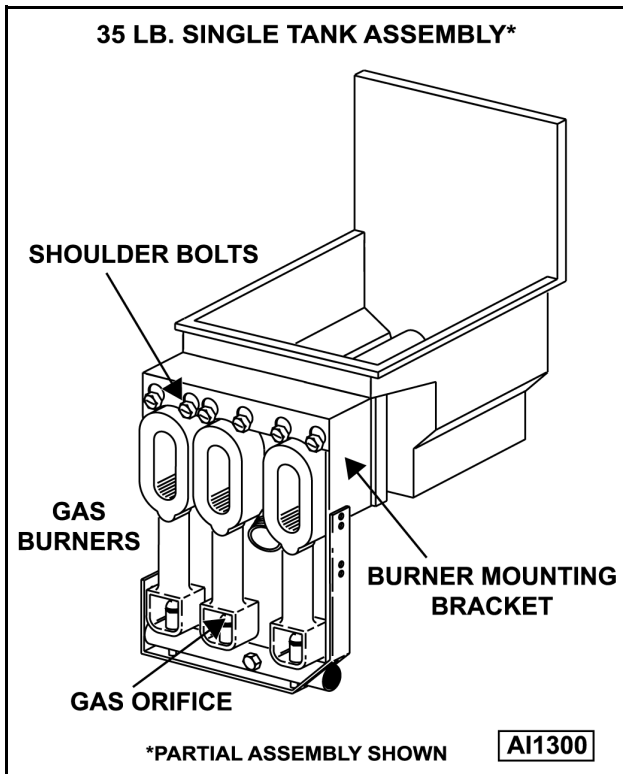

6. Remove burner.
7. Reverse procedure to install and check for proper operation.

GAS ORIFICE



⚠ WARNING Disconnect the electrical power to the machine and follow lockout / tagout procedures.

⚠ WARNING Shut off the gas before servicing the unit.

1. Remove gas orifice spud from orifice extension.

NOTICE The spud screws into orifice extension. When installing, do not over tighten the spud or damage to the threads may occur.

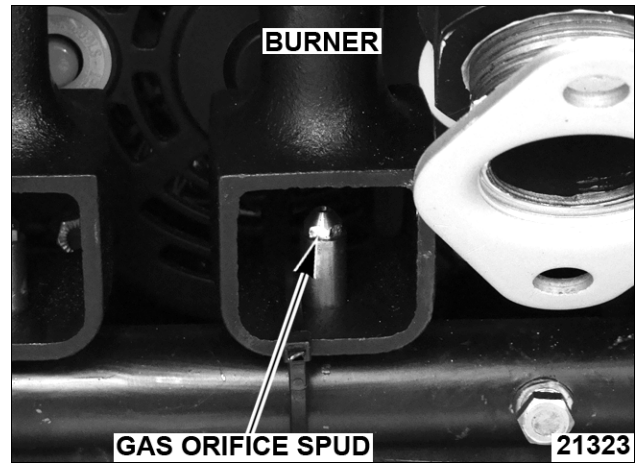

2. Reverse procedure to install and check for proper operation.

GAS COMBINATION VALVE



⚠ WARNING Disconnect the electrical power to the machine and follow lockout / tagout procedures.

⚠ WARNING Shut off the gas before servicing the unit.

⚠ WARNING All gas joints disturbed during servicing must be checked for leaks. Check with a soap and water solution (bubbles). Do not use an open flame.

NOTE: If a gas combination valve is malfunctioning, do not attempt to disassemble the valve for repair. Install a replacement gas combination valve.

1. Remove GAS BURNERS.
2. Disconnect lead wires from gas combination valve.

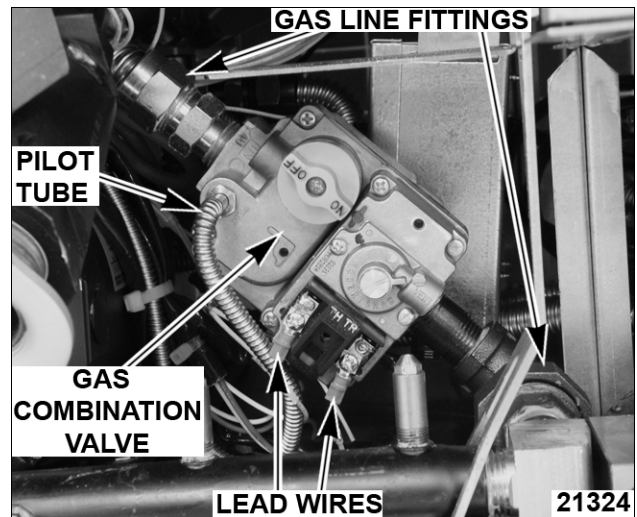

3. Disconnect pilot tube from gas combination valve.
4. Disconnect gas line fittings then remove gas combination valve.
 - A. Remove gas line fittings from gas combination valve and install (in same orientation) on the replacement valve.
5. Reverse procedure to install and check for proper operation.
 - A. Clean the pipe threads and apply pipe joint compound to threads. Any pipe joint compound used must be resistant to the action of propane gases.

GAS PILOT



⚠ WARNING Disconnect the electrical power to the machine and follow lockout / tagout procedures.

⚠ WARNING Shut off the gas before servicing the unit.

⚠ WARNING All gas joints disturbed during servicing must be checked for leaks. Check with a soap and water solution (bubbles). Do not use an open flame.

1. Remove GAS BURNERS as necessary.
2. Remove pilot burner assembly and bracket from pilot bracket stand-off on the fry tank.

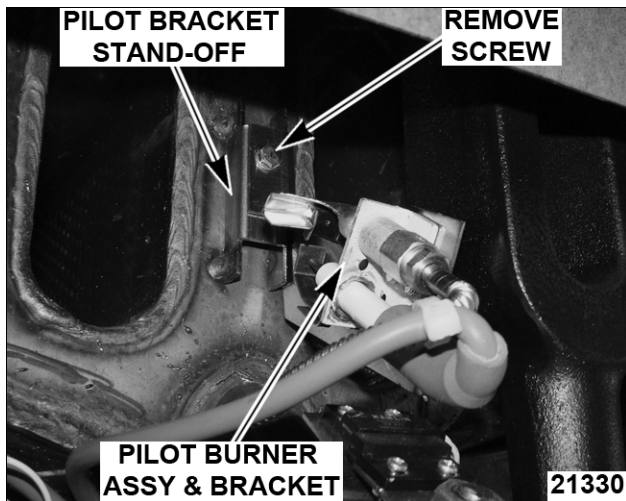

3. Remove wire tie and disconnect ignitor cable from ignitor/flame sense electrode on the gas pilot.

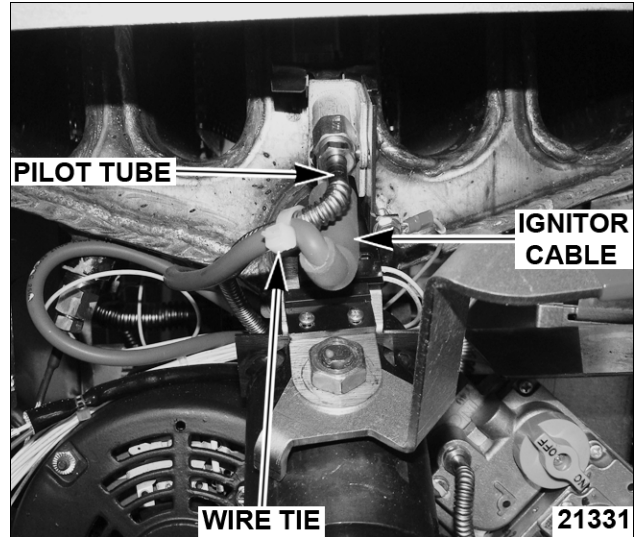

4. Disconnect pilot tube from gas pilot.
5. Remove screws (2) securing gas pilot to mounting bracket.
 - A. To remove gas orifice from pilot for inspection or cleaning, disconnect the gas orifice fitting from pilot body.
 - B. If orifice is clogged with debris, clean with air or liquid only.

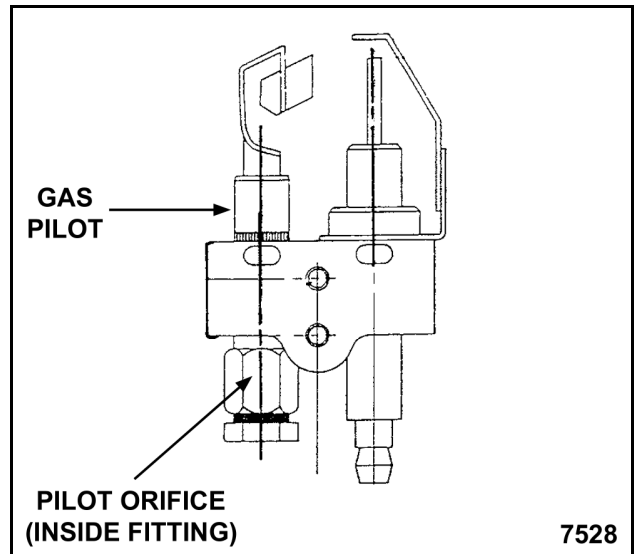

GAS PILOT FOR ELECTRONIC IGNITION SHOWN

6. Reverse procedure to install and check for proper operation.
 - A. Secure ignitor to pilot tube with wire tie.

TEMPERATURE PROBE



⚠ WARNING Disconnect the electrical power to the machine and follow lockout / tagout procedures.

⚠ WARNING Shut off the gas before servicing the unit.

NOTICE Do not sharply bend and kink, or clamp down on the capillary tube or damage may occur.

1. Drain shortening from fryer tank.
2. Disconnect smaller, 6-pin male connector. (Temperature probe and drain valve interlock (DVI) connector)

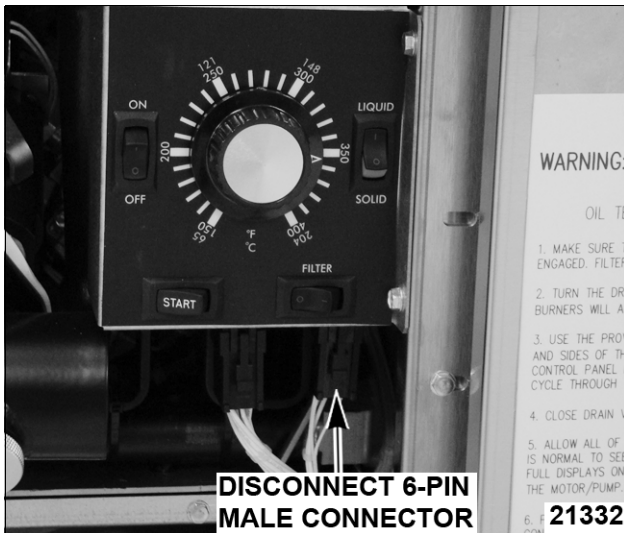

DISCONNECT 6-PIN MALE CONNECTOR

21332

3. Remove the temperature probe lead wires from pins 1 and 3 of the 6-pin male connector.
4. Remove GAS BURNERS as necessary.
5. Remove the probe retaining and packing nuts.

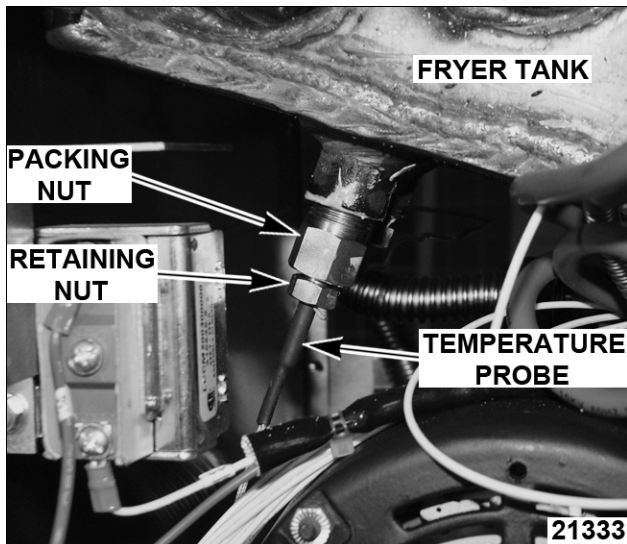

FRYER TANK

PACKING NUT

RETAINING NUT

TEMPERATURE PROBE

21333

6. Remove screws securing probe mounting clips

and probe to the fryer heat tube (inside tank) then remove probe.

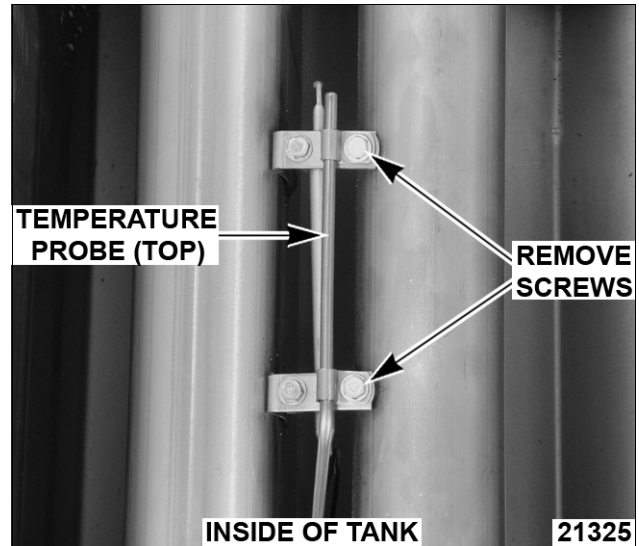

7. Reverse procedure to install and check for proper operation.

8. Check COOKING CONTROL CALIBRATION under SERVICE PROCEDURES AND ADJUSTMENTS.

HIGH LIMIT THERMOSTAT



⚠ WARNING Disconnect the electrical power to the machine and follow lockout / tagout procedures.

⚠ WARNING Shut off the gas before servicing the unit.

NOTICE Do not sharply bend and kink, or clamp down on the capillary tube or damage may occur.

1. Drain shortening from fryer tank.
2. Remove GAS BURNERS as necessary.
3. Disconnect lead wires from high limit thermostat.

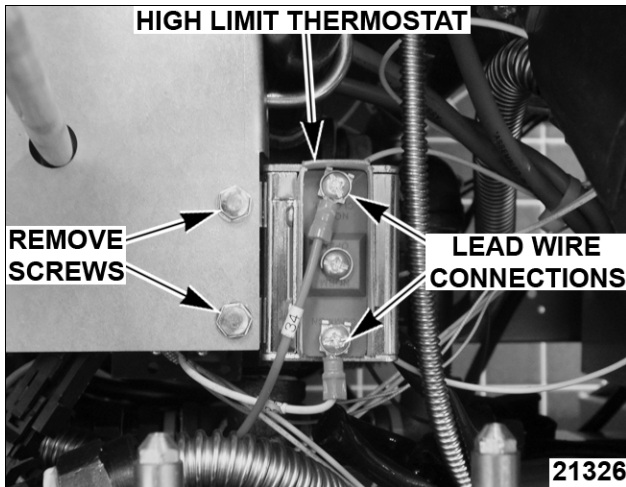

4. Remove screws securing the high limit to mounting bracket.
5. Remove the capillary tube retaining and packing nuts.

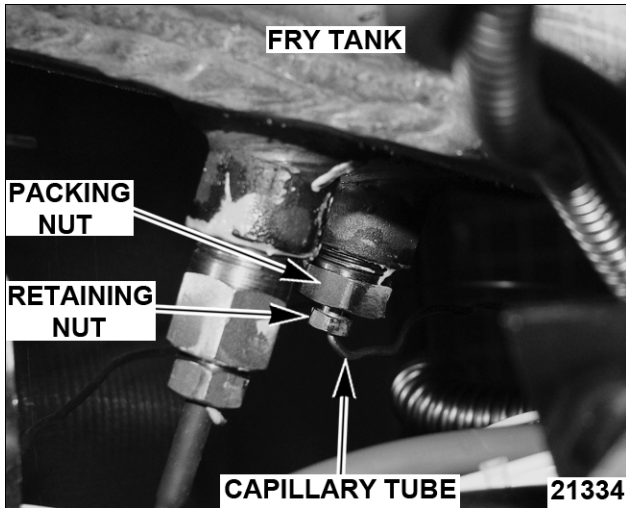

6. Remove screws securing mounting clips and capillary tube to the fryer heat tube (inside tank) then remove capillary tube.

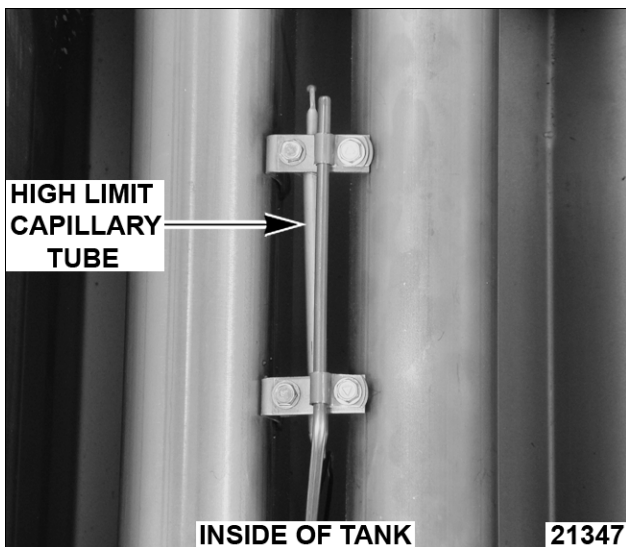

7. Reverse procedure to install.

POWER SUPPLY BOX COMPONENTS



⚠ WARNING Disconnect the electrical power to the machine and follow lockout / tagout procedures.

⚠ WARNING Shut off the gas before servicing the unit.

⚠ WARNING All gas joints disturbed during servicing must be checked for leaks. Check with a soap and water solution (bubbles). Do not use an open flame.

NOTE: The power supply box must be removed to access the following components: Ignition control module, transformer, R1 pump motor relay, R2 fill relay.

1. Disconnect all wiring harness connectors and power cords from power supply box.
2. From rear, remove screw securing power supply box to mounting bracket.

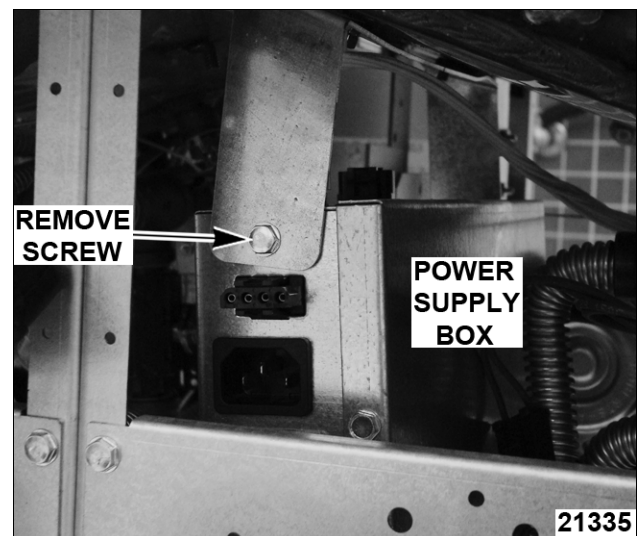

NOTE: Power supply box is slotted at the front and secured by a hanging bracket (loose fit).

3. Remove cover from power supply box.
4. Disconnect lead wires from the component being replaced then remove from power supply box.

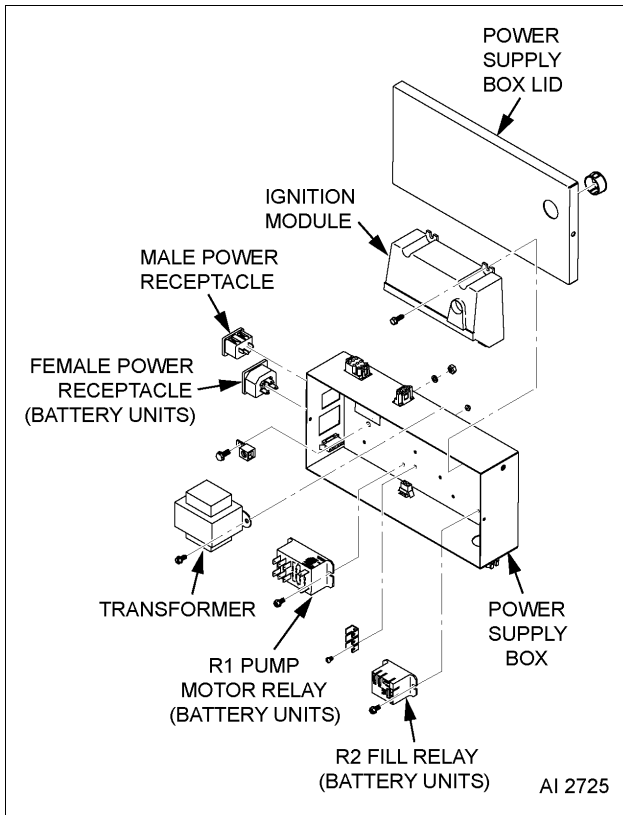

- Reverse procedure to install and check for proper operation.

FILL SOLENOID VALVE (KLEENSCREEN FRYERS ONLY)



⚠ WARNING Disconnect the electrical power to the machine and follow lockout / tagout procedures.

⚠ WARNING Shut off the gas before servicing the unit.

- Open the fryer section doors above filter pan.
- Pull filter drawer out, remove filter tank assembly and push the tank support arms back into place under the fryer.
- Remove splash guard.

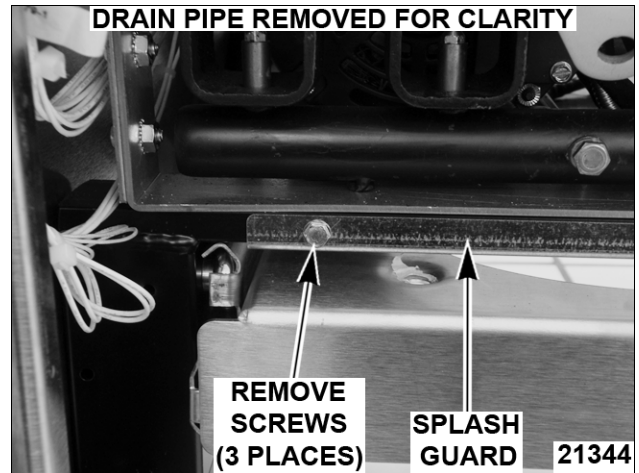

- Disconnect swivel pipe fitting at rear of fry tank.

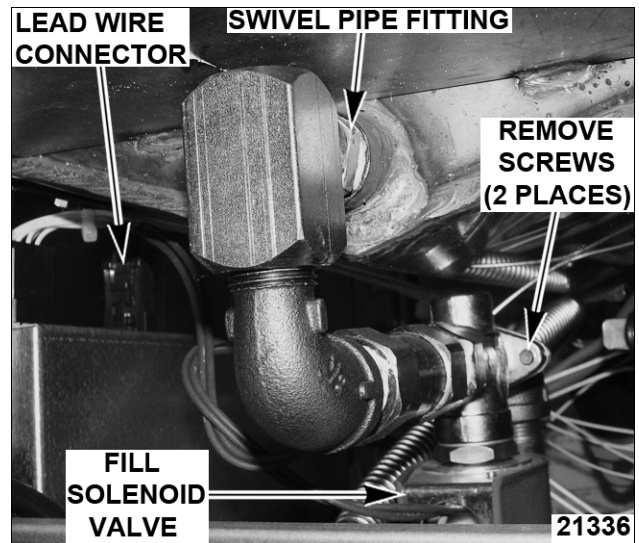

REAR VIEW SHOWN

- Disconnect fill solenoid valve lead wire connector (4 pin) from power supply box.
- Remove screws (2) securing the solenoid valve body flange to pipe tee then remove the assembly from fryer.
 - Remove pipe fittings from solenoid valve and install on replacement valve.
- Reverse procedure to install and check for proper operation.

PUMP AND MOTOR (KLEENSCREEN FRYERS ONLY)



⚠ WARNING Disconnect the electrical power to the machine and follow lockout / tagout procedures.

- Drain filter tank of shortening.

2. Open the fryer section doors above the filter tank drawer.
3. Pull filter drawer out, remove filter tank assembly and push the tank support arms back into place under the fryer.
4. Remove splash guard from base frame.

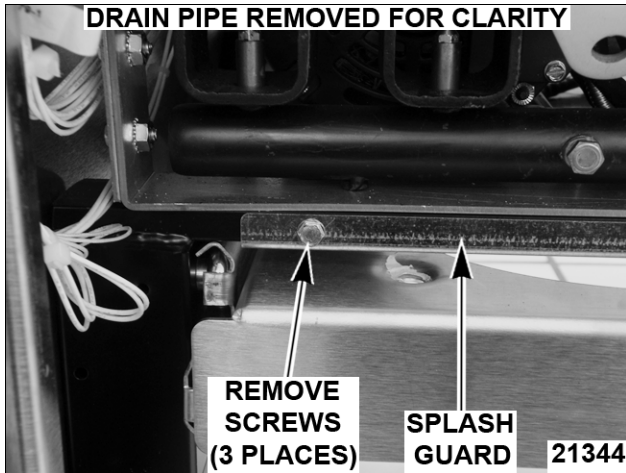

5. Disconnect pump motor lead wire connector.
6. From underneath the fryer:
 - A. Disconnect flexible line fittings from pump.
7. Remove pump motor assembly from fryer.

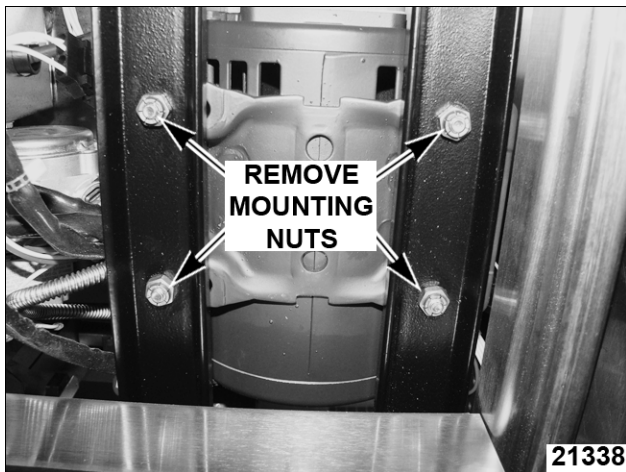

- A. Remove pipe fittings from the pump and install on replacement pump.
8. Reverse procedure to install and check for proper operation.

FRY TANK ASSEMBLY



⚠ WARNING Disconnect the electrical power to the machine and follow lockout / tagout procedures.

⚠ WARNING Shut off the gas before servicing the unit.

⚠ WARNING All gas joints disturbed during servicing must be checked for leaks. Check with a soap and water solution (bubbles). Do not use an open flame.

1. Drain shortening from fryer tank.
2. Disconnect the gas supply line to allow access to fryer from all sides.
3. Remove fryer baskets, crumb screen and basket hanger.

NOTE: If the fryer is a battery section, remove grease strip and split the silicone seal between the fryer section tanks with a utility knife.

4. On battery fryer sections only, remove bolts securing the drain pipe flange to the manual drain valve.

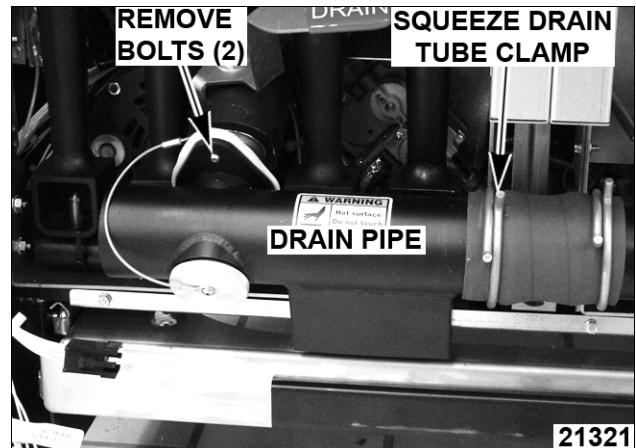

5. Disconnect temperature probe and drain valve interlock switch (DVI) connector (6 pin).

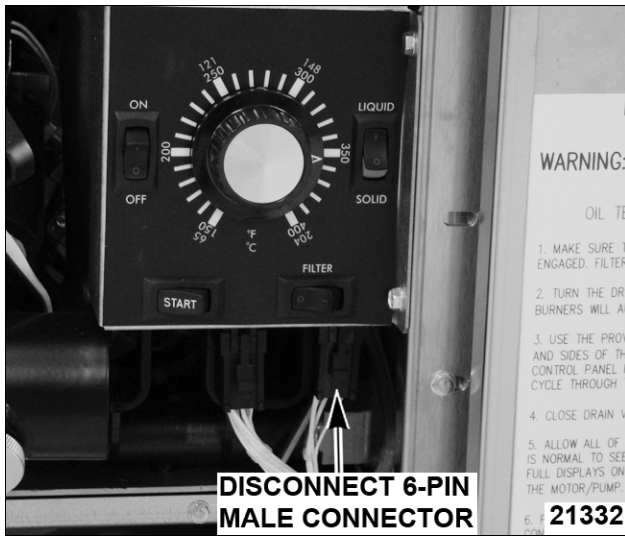

6. Remove POWER SUPPLY BOX.
7. On battery fryer sections only, remove splash guard from base frame.

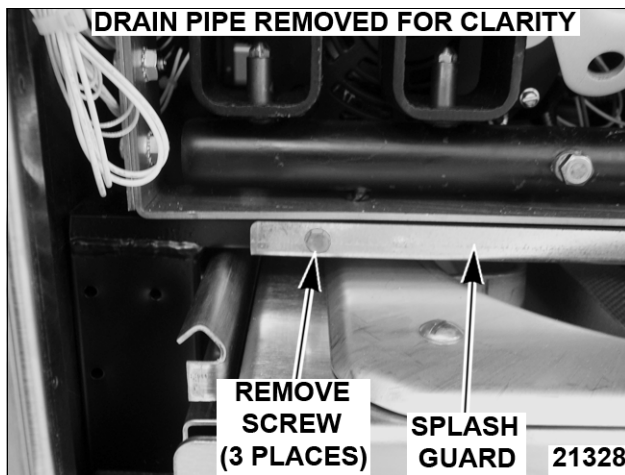

8. Remove gas manifold and frame assembly from the fryer's base frame:
 - A. Remove gas burners as necessary.
 - B. For the fryer sections above the filter drawer assembly on battery fryers or single floor model fryers, remove mounting nuts securing gas manifold and frame assembly to the fryer's base frame.
 - C. For all other fryer sections in a battery only, remove mounting nuts securing gas manifold and frame assembly to the V shaped frame support bracket.

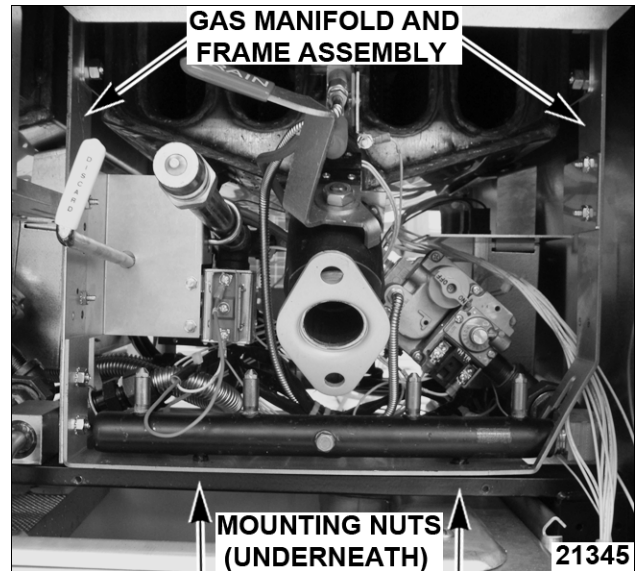

9. Disconnect swivel fitting from fry tank at the rear (shortening line inlet to fry tank).
 10. Disconnect flexible gas line fitting at manual shutoff valve (gas supply inlet to valve).
 11. Remove screws securing the top of fry tank to the flue wrap.
- NOTE:** Remove wire ties securing lead wires and wiring harnesses as necessary before removing fry tank; and when removing components from fry tank for reuse.
12. Grasp the fry tank at the top (by flue) and front lip, then lift fry tank assembly from the fryer body. Place the assembly on floor or table for removal of components.
 13. Remove GAS PILOT.
 14. Remove TEMPERATURE PROBE.
 15. Remove HIGH LIMIT THERMOSTAT.
 16. On battery fryer sections only, when removing fry tank from sections with the mechanical discard valve:
 - A. Loosen u-bolt securing discard pipe with male quick disconnect fitting to the mounting bracket.
 - B. Remove pipe from elbow on mechanical discard valve.

17. Remove bolts securing gas manifold and frame assembly to the fry tank.
18. Pull the gas manifold assembly from fry tank.
19. Disconnect drain valve interlock switch (DVI) connector (2 pin) and remove manual drain valve.
20. Remove screws securing flue box to fry tank then remove flue box.
21. Reverse procedure to install all the parts removed from original fry tank onto replacement fry tank, then install the assembly.

SERVICE PROCEDURES AND ADJUSTMENTS

⚠ WARNING Certain procedures in this section require electrical test or measurements while power is applied to the machine. Exercise extreme caution at all times. If test points are not easily accessible, disconnect power and follow lockout / tagout procedures, attach test equipment and reapply power to test.

TEMPERATURE PROBE TEST

The temperature probe is an RTD (resistance temperature detector) of the thermistor type. As temperature increases the resistance value decreases.

Probe Fault

If a temperature probe fault occurs, red diagnostic LED on back of control assembly (inside control box cover) will flash. The heat demand outputs are de-activated.

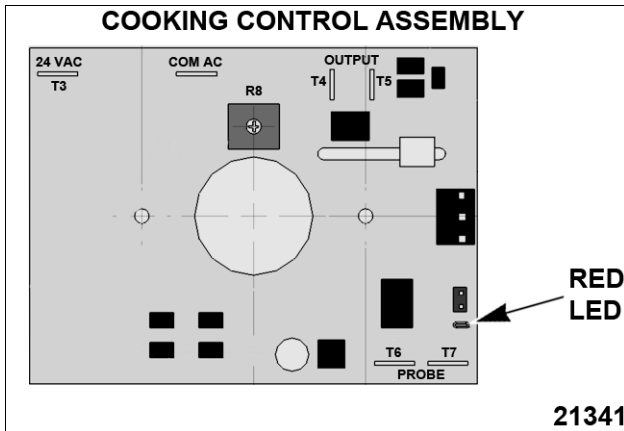

This will continue until the fault clears, power is cycled or problem resolved.

A temperature probe fault can be caused by a lead break or a lead short.

To Check:

1. Turn power switch off.
2. Disconnect the temperature probe & the drain valve interlock (DVI) connector.



3. Test the probe using a VOM to measure resistance. Connect the meter leads to pins 1 & 3 on the male connector.
 - A. If the measured resistance values are within the allowable range, the probe is functioning properly. Reverse procedure to install.
 - B. If the measured resistance values are outside the allowable range, install a replacement probe and check for proper operation.

Temperature (°F)	Resistance (Ω)
32	315,915 - 386,119
77	90,000 - 110,000
212	5,016 - 6,130
275	1,804 - 2,204
300	1,254 - 1,534
350	604 - 836
460 ¹	191 - 233

NOTE: 1. Shorted probe equivalent temperature.

COOKING CONTROL CALIBRATION

NOTE: Verify condition of temperature probe as outlined under TEMPERATURE PROBE TEST before proceeding.

1. Check the level of shortening in fry tank. The level must be between the MIN & MAX fill lines before proceeding.
2. Allow shortening to cool below 300°F.
3. Place a thermocouple in the geometric center of the fry tank one inch below the shortening surface.
4. Set the cooking control to 350°F and turn the fryer on.
5. Monitor the burners as they cycle on and off.

NOTE: Agitate the shortening, to eliminate any cold zones.

- A. Allow burners to cycle three times to stabilize shortening temperature.
 - B. Record meter reading from thermocouple when the burners cycle off and on for at least two complete heating cycles.
6. Calculate the average temperature by adding the temperature reading when the burners go out to the temperature reading when the burners come on & divide this answer by 2.

$$[\text{Temp. (Burners off)} + \text{Temp. (Burners on)}] \div 2 = \text{Average Temp.}$$

$$\text{Example: } 360^\circ + 340^\circ \div 2 = 350^\circ\text{F.}$$

The average temperature should be 350°F (± 5°F).

- A. If the average temperature reading is within tolerance, cooking control is properly calibrated.
- B. If the average temperature reading is out of tolerance, loosen set screw to remove temperature knob and adjust calibration potentiometer.

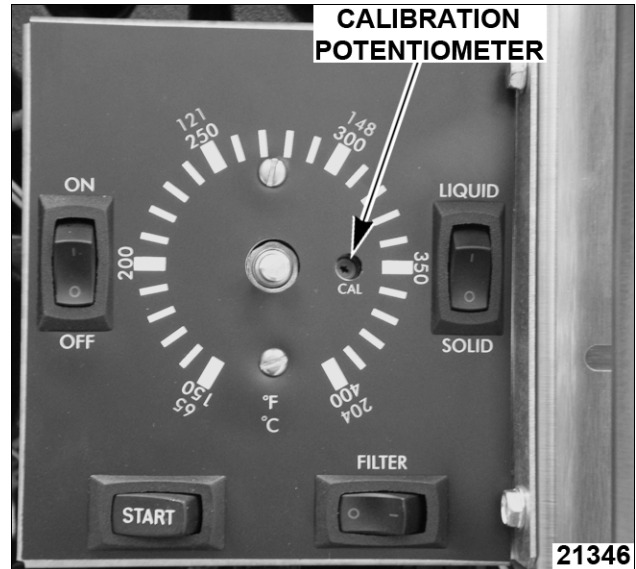

- 1) Adjust calibration potentiometer clockwise to increase temperature, and counterclockwise to decrease temperature.
 - a. If over 25° of adjustment is necessary, replace cooking control.
7. Repeat the average temperature calculation for up to three attempts. Allow the cooking control to cycle at least two times between adjustments before performing the calculation.
8. If calibration is unsuccessful, the cooking control may be malfunctioning and cannot be adjusted properly. Install a replacement cooking control and check calibration.

ELECTRONIC IGNITION SYSTEM

Operation

When the main power switch is turned on the ignition control module is energized with 24 volts between terminals 5 and 6.

An output of 24 volts is sent from terminals 2 and 3 to the pilot coil on the combination valve, allowing gas flow to the pilot; and spark voltage is sent from SPARK terminal to begin sparking at the ignitor/flame sense electrode. The sparking will continue until an adequate pilot flame is sensed or for a maximum of 90 seconds.

If pilot is not established within the 90 second ignition trial time, the ignition module locks out power to the gas valve. Controls will be disabled.

The system remains locked out until the power switch is cycled to reset the system and re-start the ignition trial cycle.

Once the pilot flame is confirmed, a 24 volt output from terminal 1 will provide the ignition status input signal to the cooking control. When the cooking

control calls for heat, the heat output is activated and the main valve coil on the combination valve is then energized, allowing gas flow to the burners.

Terminal	Description
1	MV (main voltage) - 24VAC output will be present, providing the ignitor/flame sense electrode is sensing an adequate pilot flame.
2	MV/PV (common).
3	PV (pilot voltage) - 24VAC output will be present after the ignition module is powered. The voltage will remain present, providing an adequate pilot flame is sensed. If the pilot flame is not sensed within the ignition trial time, the ignition module locks out which removes the output voltage.
4	Burner ground.
5	24VAC ground.
6	24VAC hot (input).

FLAME SENSE CURRENT CHECK

1. Turn the power switch OFF.
2. Access the ignition control module in the power supply box and locate the EnviraCom™ port.

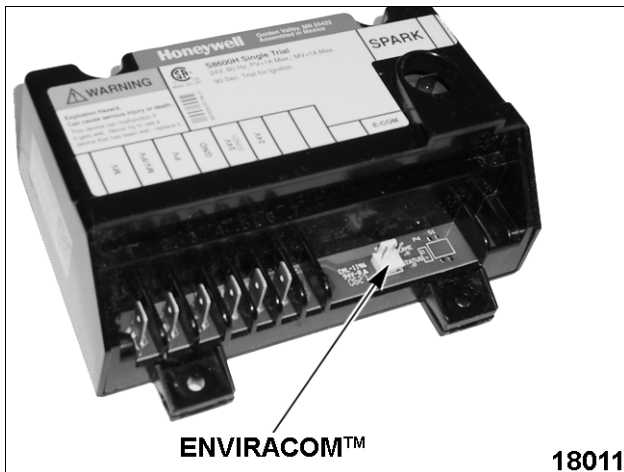

3. Connect the QuickLook™ 72 meter to the EnviraCom™ port. Turn power switch ON.

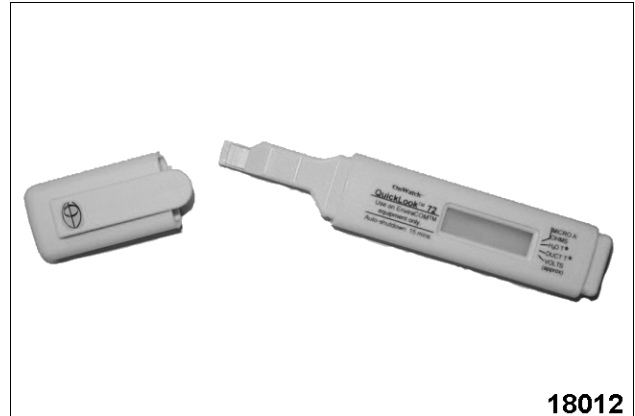

4. Meter reading should be above 1.0 micro amp (minimum) and steady.
 - A. If reading is greater than or equal to the value given, then flame sense current is within tolerance.

NOTE: Yellow Flame LED next to port should show continuous 1/2 second on-1/2 second off heartbeat.

- B. If reading is less than the value given, perform ELECTRONIC IGNITION CONTROL TEST.

ELECTRONIC IGNITION CONTROL TEST

If the ignition control module is not generating a spark to ignite gas pilot, perform the following checks.

1. Access the ignition control module in the power supply box and locate the EnviraCom™ port.

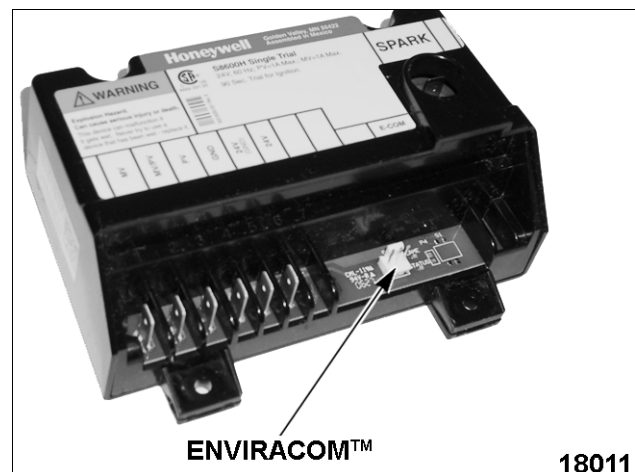

2. Connect the QuickLook™ 72 meter to the EnviraCom™ port.

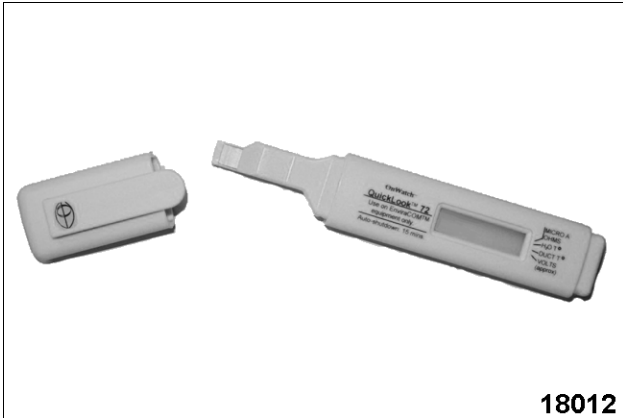

3. Turn the power switch on and verify the ignition control module is receiving power from the transformer.
 - A. If 24VAC is present, then module is receiving power. Turn the power switch off and continue with procedure.
 - B. If 24VAC is not present then find the source of the problem.
4. Disconnect power to the machine.

⚠ WARNING Shut off the gas before servicing the unit.

⚠ WARNING All gas joints disturbed during servicing must be checked for leaks. Check with a soap and water solution (bubbles). Do not use an open flame.

5. Verify all electrical connections on the ignition control module are secure.
6. Verify the ground wire connections on the ignition control module and the gas pilot mounting bracket are clean and secure. The gas pilot should have good metal to metal contact to the pilot mounting bracket on the fryer.
7. Remove the gas pilot and check the following:
 - A. Inspect the ceramic insulator on the ignitor/flame sense electrode for cracks or evidence of exposure to extreme heat, which can permit leakage to ground. If either of these conditions exist, then install a replacement gas pilot.
 - B. Inspect the ignitor electrode and ground clip for contaminants, or corrosion. Clean those surfaces as necessary.
 - C. The gap between the ignitor/flame sense electrode and the ground clip should be 1/8 inch. If the gap is outside of this dimension, bend the ground clip as necessary, to make the adjustment.

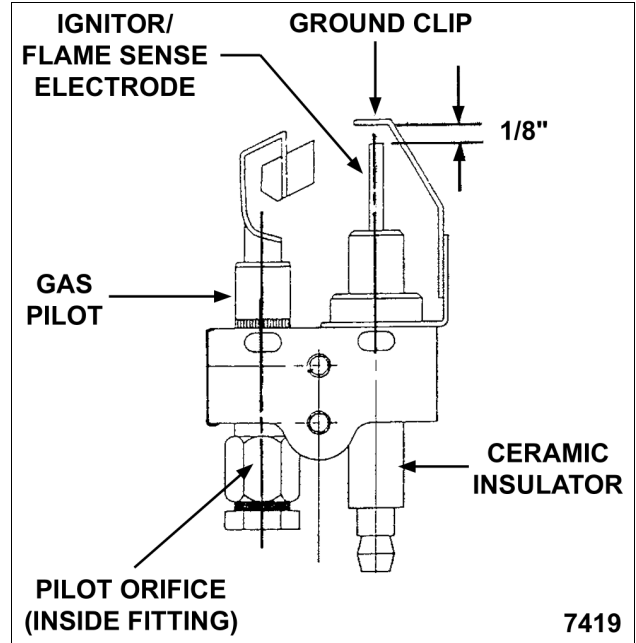

ELECTRONIC IGNITION GAS PILOT SHOWN

8. With gas pilot installed and the ignitor cable connected, reconnect power and turn the gas supply on.
9. Turn power switch on and observe spark from ignitor.
 - A. If spark from ignitor is present and ignites the gas for the pilot, and burners light, then the system is working properly.
 - B. If gas pilot lights but does not maintain an adequate flame during the trial for ignition (90 sec.), check pilot orifice for clogging.
- NOTE:** If orifice is clogged with debris, clean with air or water only.
 - C. If spark from ignitor is present but does not ignite pilot gas before the ignition control module locks out, there may not be enough gas in the line for ignition.

Turn the power switch off to re-set the module. Wait 5 minutes between ignition tries for unburned gas to vent. Turn the power switch on and sparking should resume to ignite pilot. The module may need re-set several times before ignition takes place.
 - D. If ignitor is still not sparking, turn the power switch off, disconnect power and turn the gas supply off.
10. Install a replacement ignition control module and check for proper operation.

GAS MANIFOLD PRESSURE ADJUSTMENT

1. Open the door(s) and remove drain pipe.

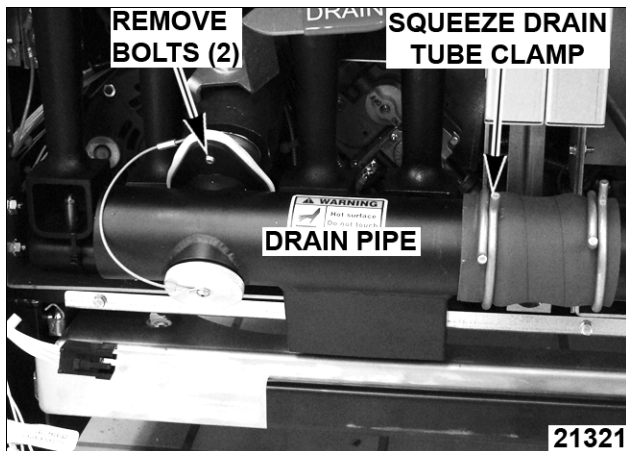

2. To measure the manifold pressure, remove plug and attach manometer to pressure tap in manifold.

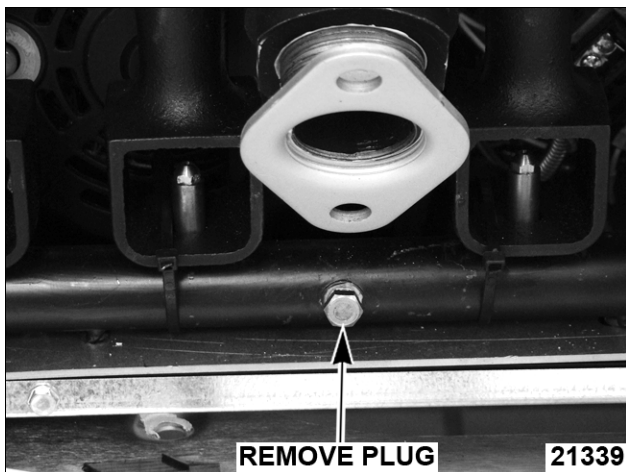

NOTE: Gas manifold pressure can also be measured by removing the 1/8 inch NPT plug (pressure tap) on the outlet side of the gas combination valve and attaching a manometer.

3. Turn the gas supply, gas combination valve and the main power switch to on.
 - A. Verify burners light.
4. Observe the manometer pressure reading and compare to the pressure chart near the end of this procedure.
 - A. If other appliances are connected to the same gas line, turn them all on and check manometer pressure reading again. If a pressure drop of 1/2 inch water column or more is observed, then the gas supply needs to be checked by the gas line installer or the local gas company for

adequate sizing.

- B. If adjustment is necessary, continue with procedure.
5. Remove burners as necessary.
6. Remove the adjustment screw cap to access the pressure adjustment screw on gas combination valve.

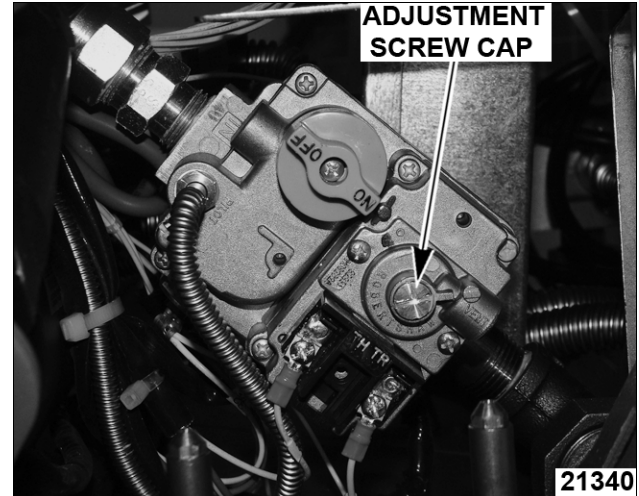

- A. To increase pressure, turn the screw clockwise. To decrease pressure, turn the screw counterclockwise.

NOTE: Accurate gas pressure adjustments can only be made with the gas on and the burner lit.

7. Set the pressure as outlined below:

GAS TYPE	PRESSURE READINGS (INCHES W.C.)			
	MANIFOLD	LINE		
		RECOMMENDED	MIN	MAX
Natural	4	7	5	14
Propane	10	11	11	

NOTE: If the incoming line pressure is less than the minimum stated, then the manifold pressure can not be set correctly.

8. Once the correct pressure has been set, turn the power switch off, replace the adjustment screw cap and manifold plug.
9. Install drain pipe and burners.
10. Check for proper operation.

ELECTRICAL OPERATION

COMPONENT FUNCTION

FRYER CONTROLS

Cooking Control	Monitors and evaluates input signals to the control: Activates heat output signal to maintain shortening temperature; and activates filter output signal to power the fill solenoid valve.
Transformer	Supplies 24VAC to the cooking control ignition control module. Transformer is energized when power switch is turned on.
Power Switch	Supplies power to control circuit for fryer operation and filtering.
Melt Select Switch	Controls burner operation based on type of shortening being used (liquid/solid).
Gas Combination Valve	Allows gas flow to the pilot when pilot valve coil is energized; and gas flow to the burners when main valve coil is energized. Also, regulates the gas manifold pressure.
High Limit Thermostat	Prevents the shortening from reaching temperatures over 450°F (auto reset @ 415°F, normal operation resumes when temperature falls below this point).
Temperature Probe	Senses temperature of shortening. Converts the temperature into a resistance which is monitored by the cooking control. The probe is an RTD (resistance temperature detector) of the Thermistor type. As temperature increases the resistance value decreases.
Ignition Control Module	Controls and monitors gas pilot ignition. Energizes pilot valve coil on the combination control valve and generates spark for pilot ignition. Monitors the presence of a flame and supplies an ignition status input signal to the cooking control.
Ignitor/Flame Sense	Ignites the gas pilot and senses the presence of a flame. The flame presence generates a micro-amp flame sense current that is rectified to the ignition control module.
Drain Valve Interlock Switch (DVI)	A magnetic reed switch mounted on the manual drain valve that supplies a drain valve position signal (open/closed) to the cooking control. When drain valve is open, the drain interlock input to the control is removed (magnetic reed switch contacts open). This prevents gas burners from coming on with the fry tank empty.

KLEENSCREEN FILTER CONTROLS

- Fill Solenoid Valve** When energized by filter switch, the solenoid valve opens to allow the flow of shortening thru filtering system.
- Pump Motor** Operates pump to circulate shortening through filtering system.
- Start Switch** Supplies power to temperature control module.
- Filter Switch** Supplies power to pump motor thru R1 and fill solenoid valve thru R2.
- Discard Valve Switch** A magnetic reed switch mounted on the mechanical discard valve that closes when discard valve handle is extended to discard the shortening. Prevents R2 filter relay N.C. contacts from supplying power to the fill solenoid valve when filter key is pressed.
- R1 Pump Motor Relay** When 24VAC relay coil is energized by filter switch, supplies 120VAC to pump motor; and fill solenoid valve thru R2 fill relay N.C. contacts.
- R2 Fill Relay** When 24VAC relay coil is energized by filter switch, supplies 24VAC to the fill solenoid valve to open the valve and allow shortening to flow thru filter system.

**POWER SUPPLY BOX
COMPONENTS**

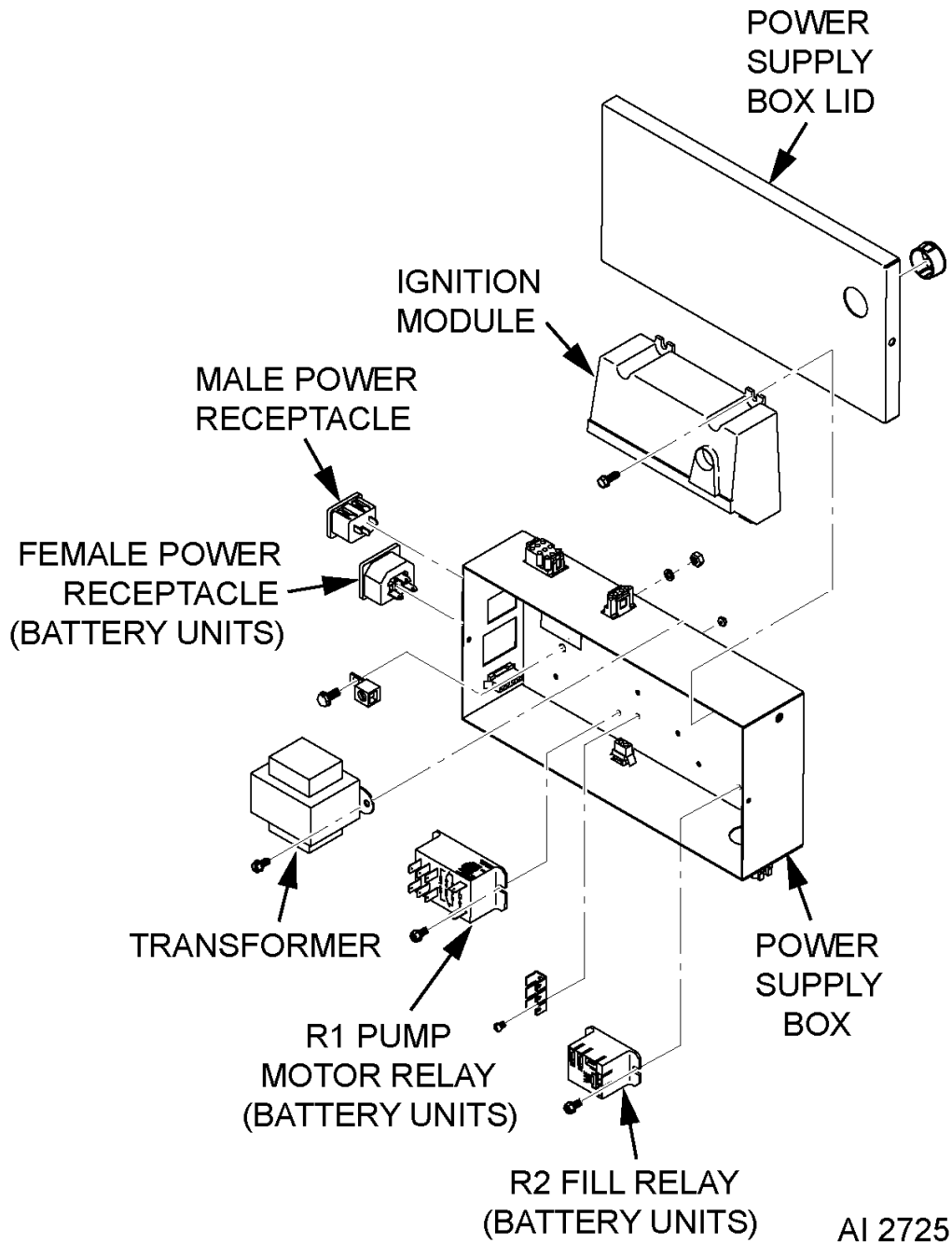

AI 2725

SEQUENCE OF OPERATION

Refer to schematic diagram AI 2727 for Cooking Control operation.

NOTE: Make sure melt select switch reflects type of shortening being used (solid/liquid).

1. Conditions.
 - A. Fryer connected to correct supply voltage and properly grounded.
 - B. Gas supply is on and gas combination valve is open.
 - C. Power switch to the fryer section in the off position.
 - D. Shortening at proper level in fry tank and below last set point temperature used.
 - E. Manual drain valve closed (drain valve interlock switch N.O. is closed).
 - F. High limit thermostat closed.
2. Turn power switch on.
 - A. 24VAC transformer energized.
3. Ignition module is powered (24VAC), initializes and generates spark at ignitor.
 - A. Pilot voltage (PV) N.O. contacts close, pilot valve coil energized and valve opens for gas flow to pilot.
 - 1) Pilot flame established. A micro amp *flame sense* current is rectified to ignition module through ignitor cable and sparking stops.
 - 2) Main voltage (MV) N.O. contacts close and provides ignition status input signal (24VAC) to cooking control.
 - B. If pilot is not established within 90 seconds of the ignition module being energized, the ignition module locks out power to gas valve.
 - 1) The system remains locked out until the power switch is cycled to reset the system and re-start the ignition trial cycle. (wait 5 minutes for gas to dissipate)
4. Cooking control evaluates input signals from: Ignition status; Drain valve interlock; and temperature probe.
 - A. Main valve coil energized and valve opens for gas flow to burners.
 - 1) Burners light and heat the shortening in fry tank.

NOTE: As long as the ignition control module senses a pilot flame, the internal main voltage (MV) contacts (N.O.) on the ignition module remain closed, and main gas valve stays on.
5. Shortening reaches set temperature.
 - A. Cooking control de-activates the heat output (24VAC).
 - 1) Main valve coil de-energized and valve closes.
 - 2) Gas flow stops and burners go out.
6. Cooking control cycles heat output on shortening temperature until: power switch is turned off; ignition input status is removed; drain valve interlock input status is removed; temperature probe input is outside acceptable limits or a high limit condition occurs.
7. If shortening reaches 450°F or higher: high limit thermostat opens, power is removed from the pilot valve coil and valve closes to stop pilot gas flow.
 - A. Ignition trial cycle will start but pilot will be unable to light.
 - B. Fryer operation can resume when the temperature drops below 415°F.

Kleenscreen Filtering System

Refer to schematic diagram AI 2728 for Kleenscreen Filter System operation. Refer to Installation & Operation manual and Kleenscreen Filtration System Supplement manual for specific instructions on filtering.

NOTE: The discard valve handle is connected to a mechanical valve and magnetic reed switch assembly to route the flow of shortening in the filtering system and supply power to the pump motor.

1. Conditions.
 - A. Fryer connected to correct supply voltage and is properly grounded .
 - B. Power switch to fryer section to filter turned on.
 - C. The cooking control should be setup properly and ready to use.
 - D. Cooking control temperature setting between 300°F (minimum) and 350°F (maximum).

NOTE: Shortening should not be filtered outside of this temperature range. At lower temperatures the shortening is thicker which may increase filtering time and place a greater load on the pump. At higher shortening temperatures, oil seal life is decreased.

- E. Filter drawer assembly installed properly.
 - F. Discard valve handle (yellow) retracted.
 - 1) Discard valve switch N.O. contacts open. Mechanical discard valve closed.
2. Allow shortening to cycle between 300°F and 350°F for approximately 10 minutes.

NOTE: If using solid shortening, once it has melted, stir the shortening to eliminate any solid shortening in cold zone of the fry tank.

3. Open the drain valve to the fryer section in need of filtering and drain the shortening into filter tank.
 - A. Drain valve interlock contacts open and the position of the drain valve is indicated to the cooking control.

NOTE: If using solid shortening, allow hot shortening to stand in filter tank for approximately 6 minutes prior to filtering.

4. Turn filter switch on cooking controls to ON.
 - A. R1 pump motor relay coil (24VAC) is energized and both sets of N.O. contacts close.

NOTE: Jumper wire number 24 connects one set of R1 N.O. contacts to R2 COM.

 - 1) Fill solenoid valve is energized (120VAC) thru R2 fill relay N.C. contacts and valve opens.
 - 2) Pump motor is energized (120VAC) and pump circulates shortening through filtering system.

5. When filtering is completed, close the drain valve and allow the fry tank to refill.
 - A. Drain valve interlock contacts close and the position of the drain valve is indicated to the cooking control.

6. When all filtered shortening is returned to the fry tank, turn filter switch on cooking controls to OFF.
 - A. Power is removed from fill solenoid valve and pump motor.

NOTE: If using solid shortening, when all filtered shortening is returned to the fry tank and pump motor is off, open the filter drawer approximately one inch. Allow the remaining shortening in the line to drain into the filter tank to prevent possible clogging after the shortening cools and solidifies. Close the filter drawer when complete.

SCHEMATIC DIAGRAMS

Fryers Without KleenScreen Filtration System

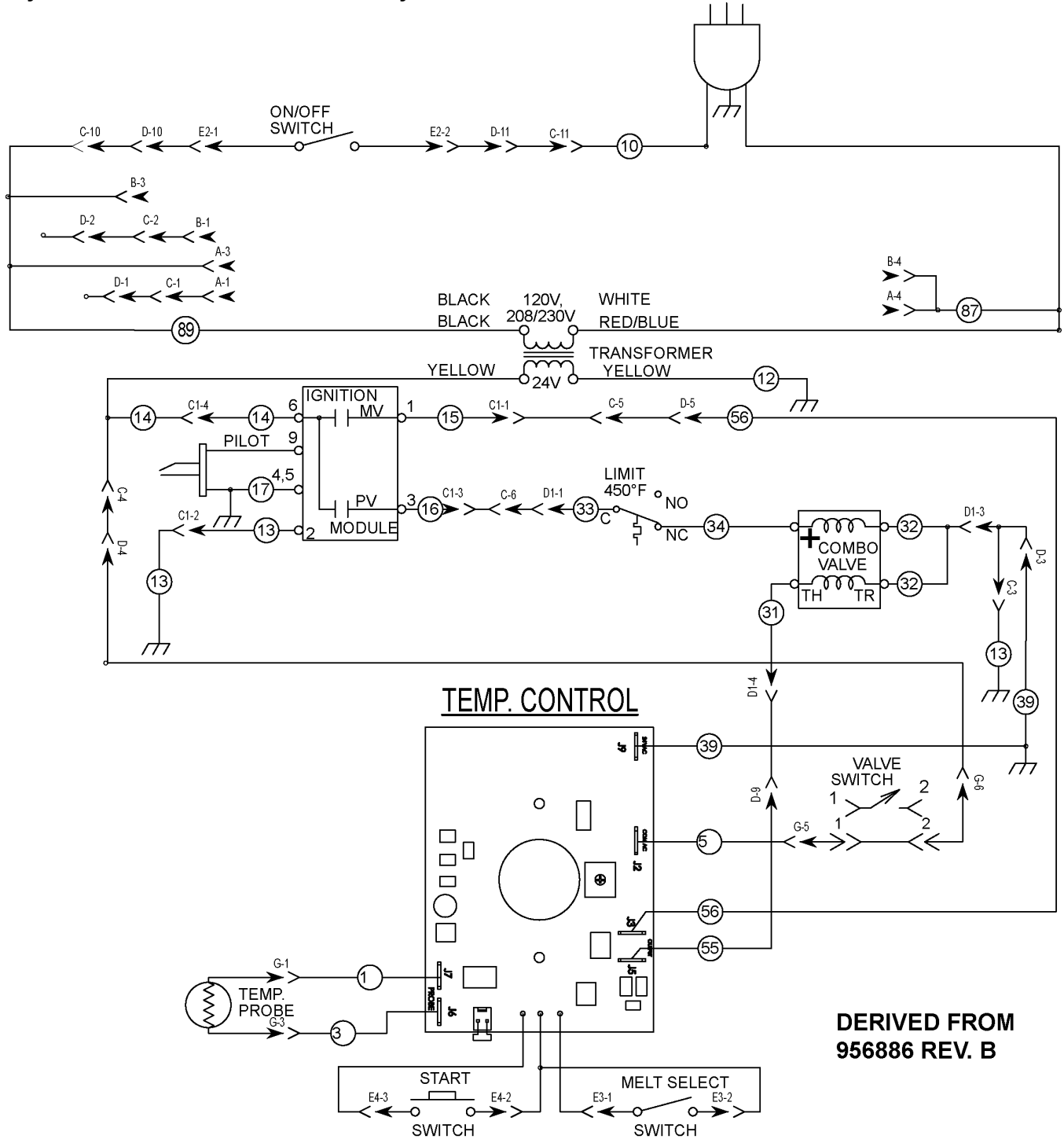

**DERIVED FROM
956886 REV. B**

AI 2727

Fryers With KleenScreen Filtration System

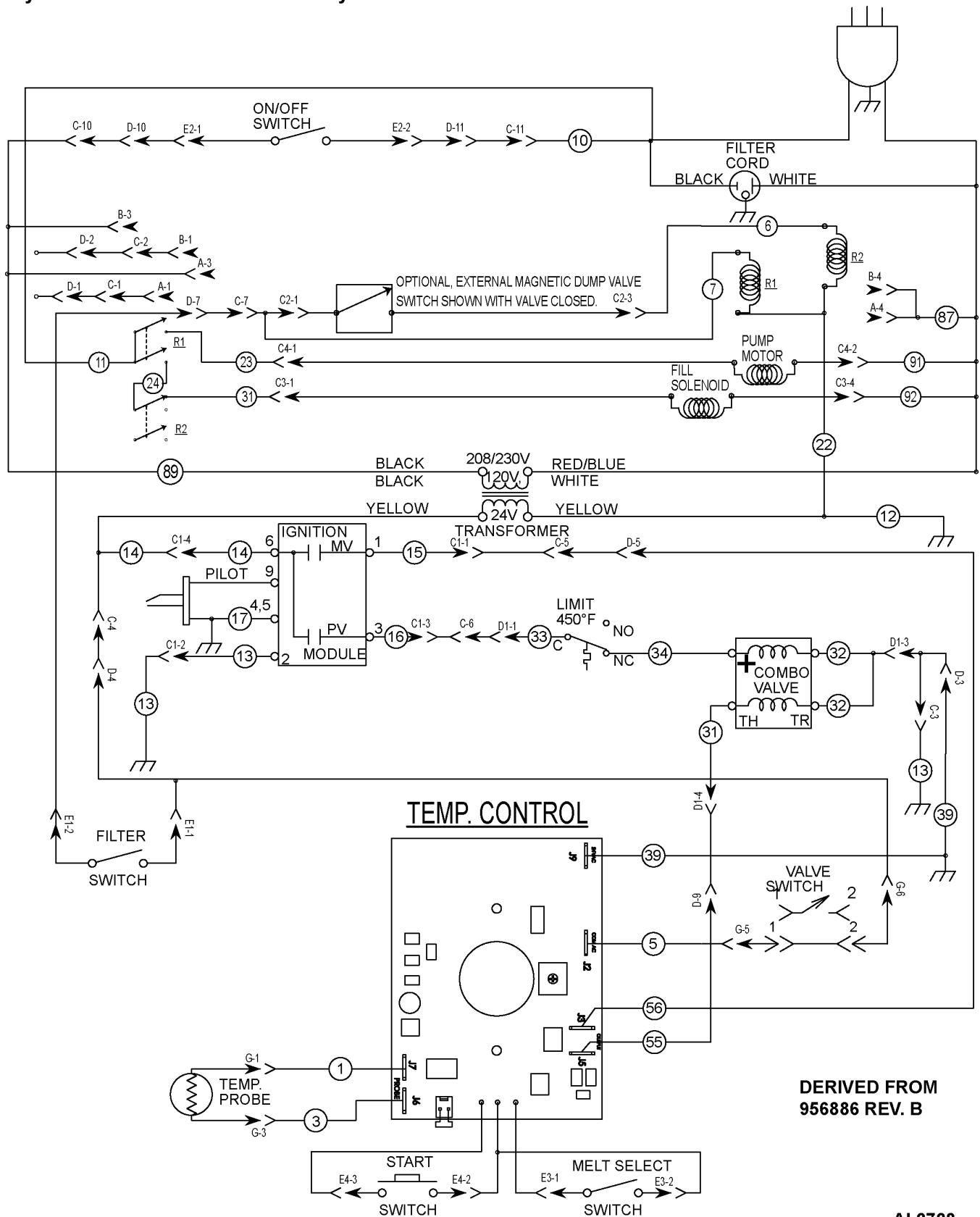

DERIVED FROM
956886 REV. B

AI 2728

WIRING DIAGRAMS

Fryers Without KleenScreen Filtration System

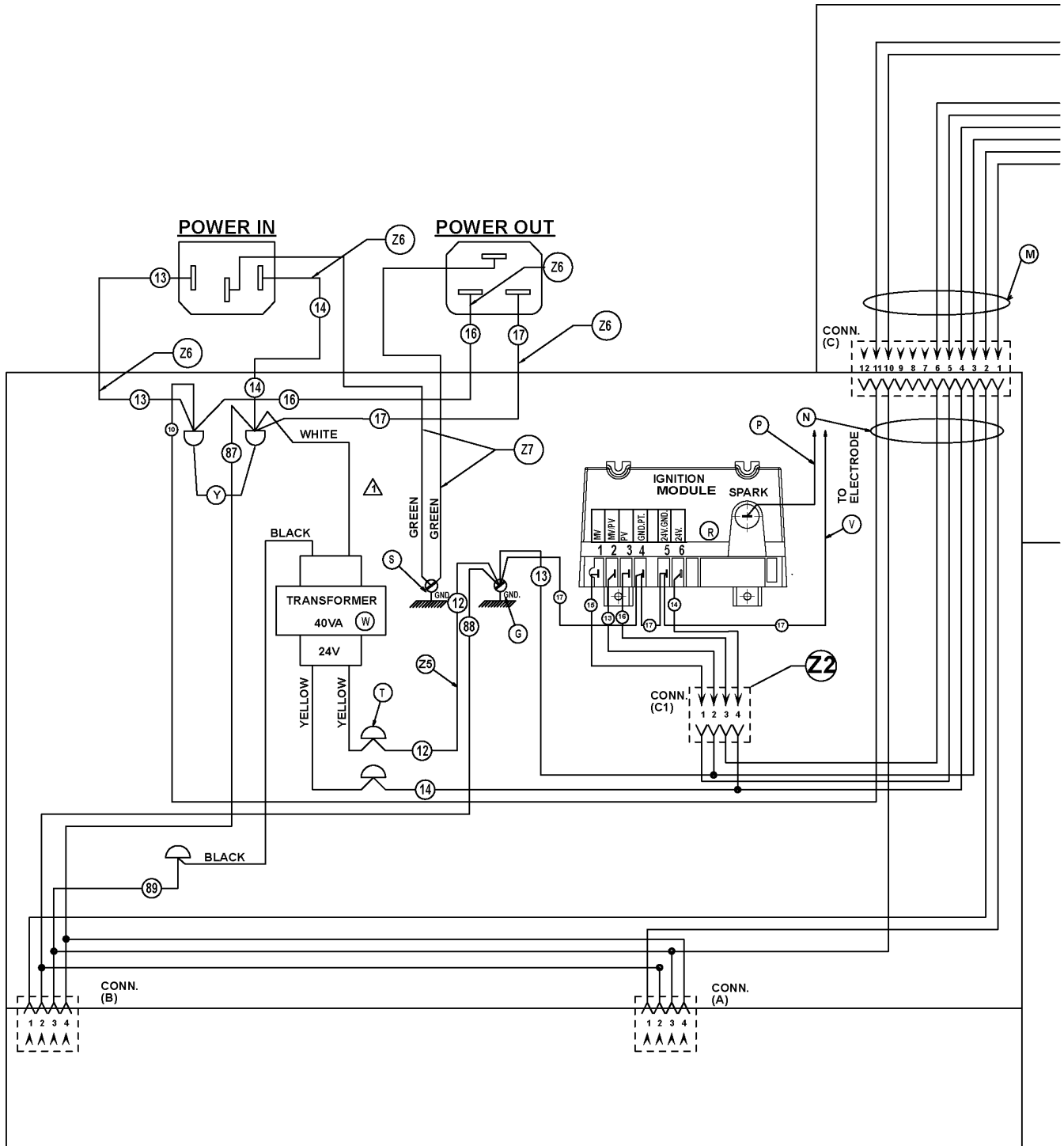

**PAGE 1 OF 2
(SEE AI 2734)**

AI 2733

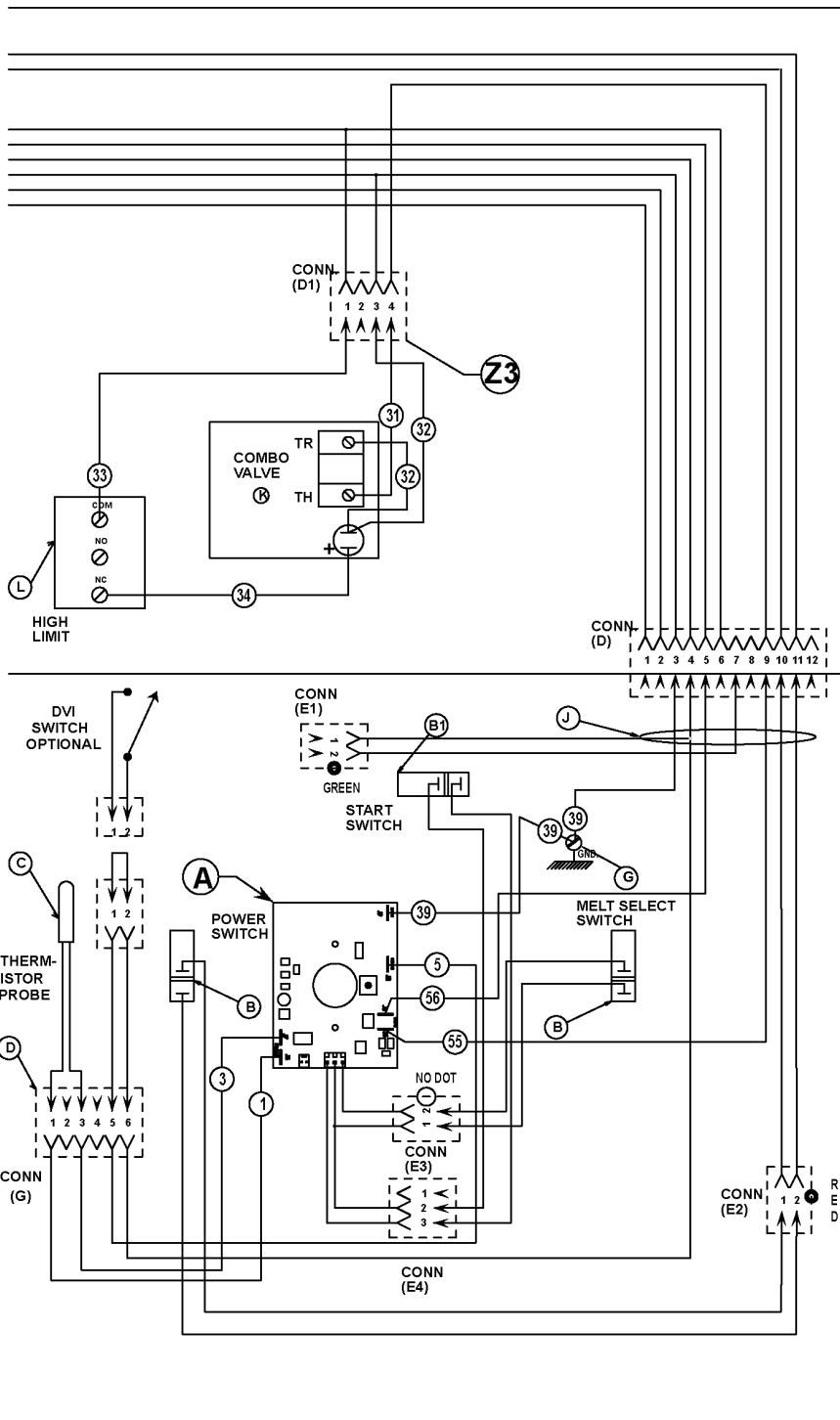

2	Z7	WIRE ASSEMBLY (GREEN)	-
4	Z6	WIRE ASSEMBLY [13,14,16,17]	-
1	Z5	WIRE ASSEMBLY [12]	-
1	Z3	MANIFOLD HARNESS	-
1	Z2	HARNESS-IGNITION MODULE	-
1	Z1	OPTIONAL FILTER SUPPLY CORD	-
2	Y	WIRE NUT YELLOW	-
1	W	24V 40VA TRANSFORMER	120 VOLT 240 VOLT
1	V	LEAD ASSEMBLY [17]	-
3	T	WIRE NUT	-
1	S	GROUND LUG	-
1	R	IGNITION MODULE	-
1	P	IGNITOR CABLE	-
1	N	POWER HARNESS	-
1	M	MAIN HARNESS	-
1	L	HI-LIMIT	-
1	K	COMBO VALVE	NAT LP
1	J	INTERFACE HARNESS	-
2	G	TERMINAL, STATIONARY	-
1	D	D.V.I. HARNESS ASSEMBLY	-
1	C	THERMISTOR	-
1	B1	ROCKER SWITCH ASSEMBLY-MOM.	-
2	B	ROCKER SWITCH ASSEMBLY	-
1	A	NCC CONTROL	-

DERIVED FROM
956751-1 REV. B

PAGE 2 OF 2
(SEE AI 2733)

AI 2734

Fryers With KleenScreen Filtration System

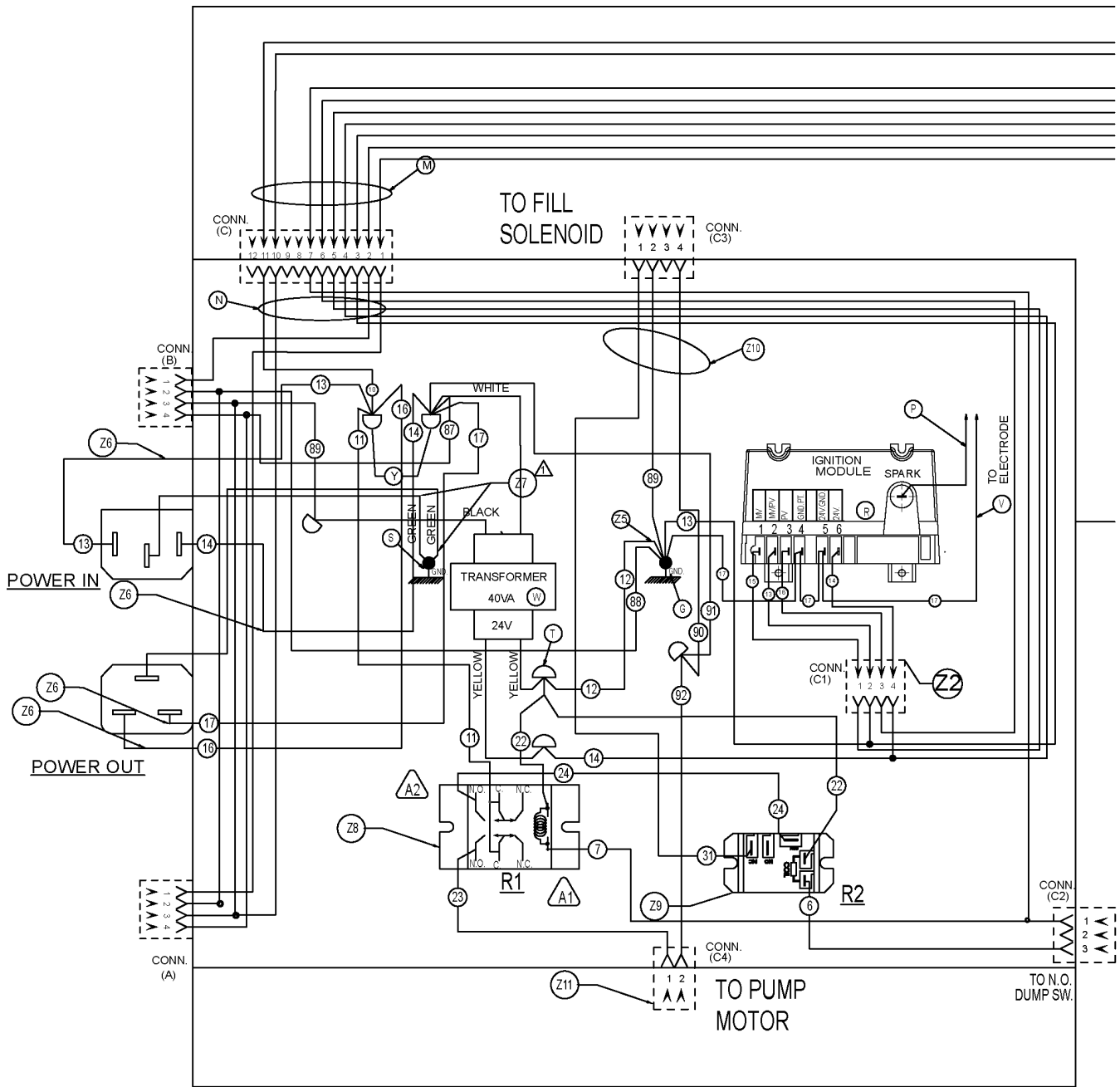

PAGE 1 OF 2
(SEE AI 2732)

AI 2729

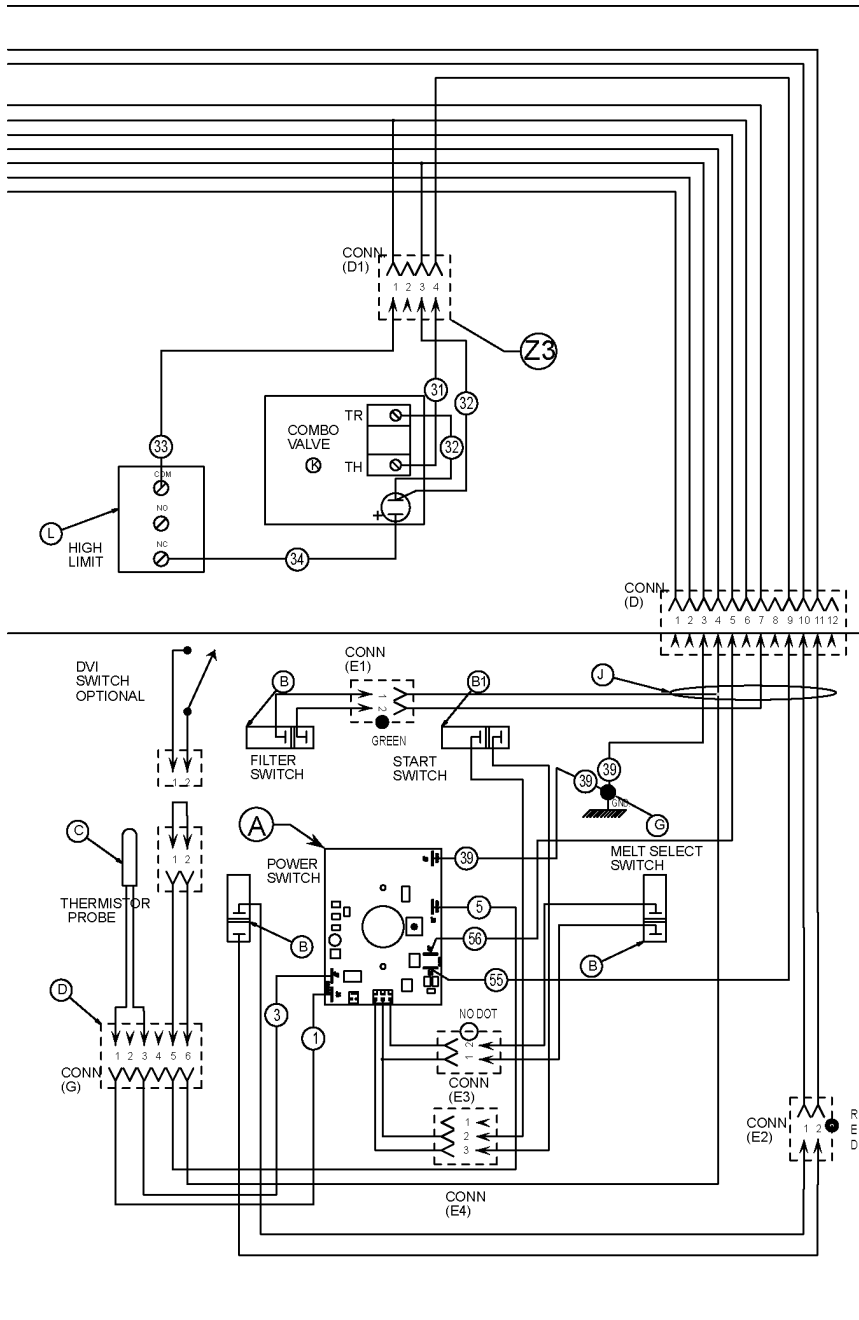

1	Z11	HARNES, MOTOR CONNECT	
1	Z10	HARNES, SOLENOID CONNECT	
1	Z9	RELAY SPST 24 VAC COIL	
1	Z8	RELAY 1 HP 120 VOLT	
2	Z7	WIRE ASSEMBLY (GREEN)	
4	Z6	WIRE ASSEMBLY [13,14,16,17]	
1	Z5	WIRE ASSEMBLY [12]	
1	Z3	MANIFOLD HARNES	
1	Z2	HARNES-IGNITION MODULE	
1	Z1	OPTIONAL FILTER SUPPLY CORD	
2	Y	WIRE NUT YELLOW	
1	W	24V 40VA TRANSFORMER	120 VOLT
			240 VOLT
1	V	LEAD ASSEMBLY [17]	
3	T	WIRE NUT	
1	S	GROUND LUG	
1	R	IGNITION MODULE	
1	P	IGNITOR CABLE	
1	N	POWER HARNES	
1	M	MAIN HARNES	
1	L	HI-LIMIT	
1	K	COMBO VALVE	NAT
			LP
1	J	INTERFACE HARNES	
2	G	TERMINAL, STATIONARY	
1	D	D.V.I. HARNES ASSEMBLY	
1	C	THERMISTOR	
1	B1	ROCKER SWITCH ASSEMBLY-MOM.	
3	B	ROCKER SWITCH ASSEMBLY	
1	A	NCC CONTROL	

**DERIVED FROM
956751-2 REV. B**

**PAGE 2 OF 2
(SEE AI 2729)**

AI 2732

Frymate (Dump Station)

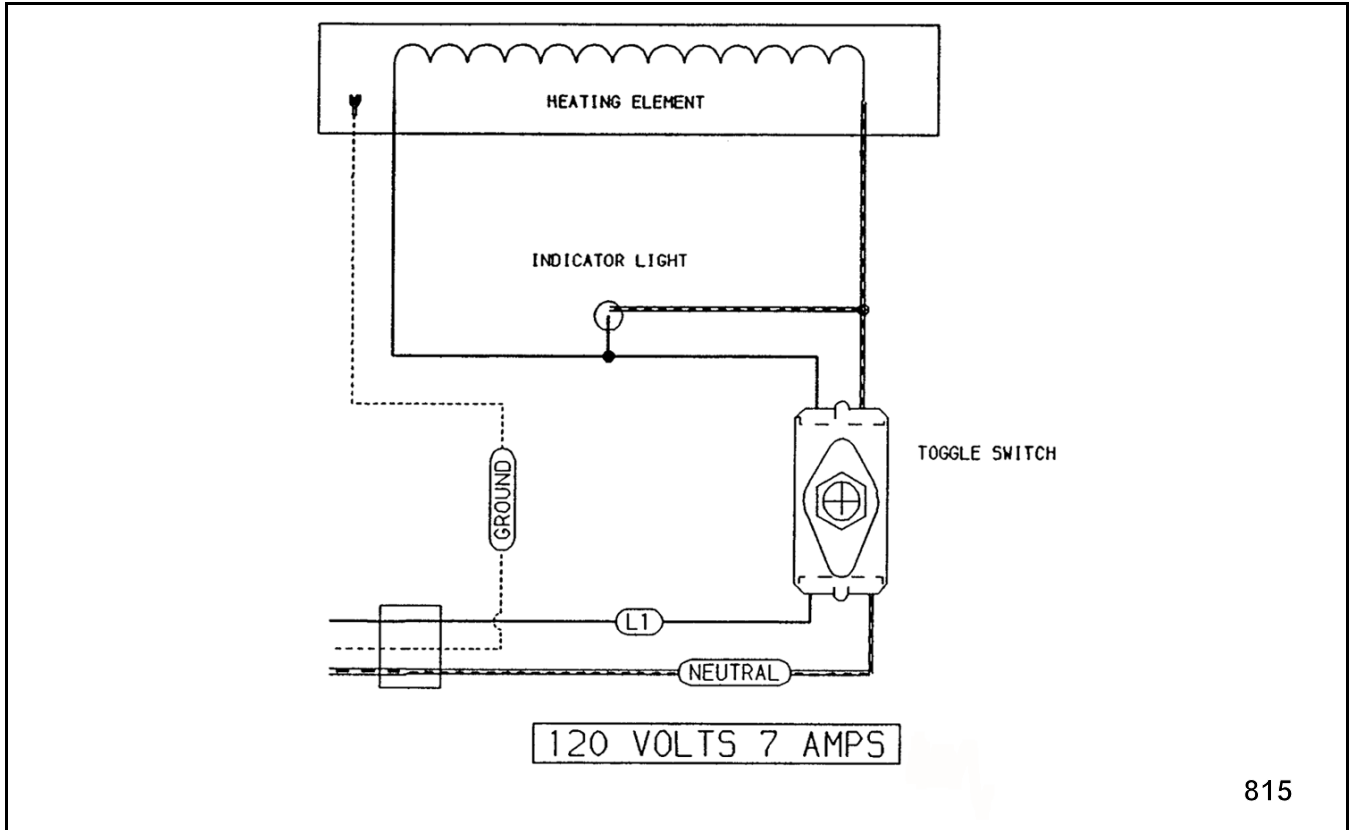

815

TROUBLESHOOTING

ALL MODELS

SYMPTOMS	POSSIBLE CAUSES
No spark to ignite pilot gas.	<ol style="list-style-type: none"> 1. Drain valve switch open or switch malfunction. 2. Shorted electrode or an improper ground on ignitor/flame sense. 3. Ignitor cable open. 4. Interconnecting wiring malfunction. 5. Ignition Module malfunction.
Sparks but gas does not ignite.	<ol style="list-style-type: none"> 1. Service gas valve closed. 2. Gas supply off or insufficient gas pressure. 3. Gas supply quick disconnect coupling not properly mated. 4. Gas combination valve off or inoperative. 5. High limit thermostat open. 6. Interconnecting wiring malfunction. 7. Ignition Module malfunction.
Gas pilot ignites but will not maintain flame.	<ol style="list-style-type: none"> 1. Ignitor ground inoperative. 2. Ignitor/flame sense misaligned or malfunction. 3. Insufficient gas pressure. 4. Ignition module malfunction.
Gas burners ignite but will not maintain flame.	<ol style="list-style-type: none"> 1. Gas pressure incorrect. 2. Gas orifice obstructed or incorrect. 3. Burner malfunction. 4. Gas pilot malfunction.
Excessive or low heat.	<ol style="list-style-type: none"> 1. Cooking controls need calibrated. 2. Temperature probe malfunction. 3. Gas pressure incorrect. 4. Gas orifice obstructed or incorrect. 5. Cooking control malfunction. 6. Interface board malfunction.
Intermittent problems.	<ol style="list-style-type: none"> 1. High ambient temperatures. 2. Wiring connections loose.
No power to cooking control, fryer does not heat.	<ol style="list-style-type: none"> 1. Power switch off or malfunction. 2. Transformer inoperative. 3. Interconnecting wiring malfunction.
High limit thermostat shutting off gas burners.	<ol style="list-style-type: none"> 1. Shortening level below minimum fill line. 2. Probe malfunction. 3. Cooking control malfunction. 4. High limit thermostat malfunction.
Excessive time to melt shortening (more than 45 minutes).	<ol style="list-style-type: none"> 1. Insufficient gas pressure. 2. Gas orifice plugged or obstructed. 3. Probe malfunction. 4. Cooking control malfunction.

IGNITION MODULE

The ignition module has two LED's; one for flame sensing and one for ignition system status.

- Flame LED (Yellow) - Indicates pilot burner flame presence and signal strength.
- Status LED (Green) - Indicates ignition system operation status and error conditions.

LED Flash Code Descriptions - Flame LED (yellow) or Status LED (green):

- Fast Flash - Rapid blinking during startup and self check.
- Heartbeat - Cycles bright 1/2 second; dim 1/2 second.
- Single Flash - LED flashes X times at 2Hz, remains off for two seconds then repeats flash sequence.
- Double Flash - LED flashes X times at 2Hz, remains off for two seconds, flashes Y times at 2Hz, remains off for three seconds then repeats flash sequence (X+Y).

FLAME LED CODES (YELLOW) - PART NO. 857207-1 IGNITION MODULE

LED Flash Code	Indicates	Possible Causes
<i>Heartbeat</i>	Normal pilot flame signal	None
2	Weak pilot flame signal. Ignition system will operate reliably but flame signal is less than desired. NOTE: Code may flash temporarily just after pilot burner lights then operate normally after flame signal stabilizes.	Check the following: 1. Gas supply. 2. Pilot burner flame. 3. Spark/flame sense wiring. 4. Flame sense electrode contaminated or out of position. 5. Pilot burner ground.
1	Marginal pilot flame signal (less than 2 μ A). Ignition system may not operate reliably over time. NOTE: Code may flash temporarily just after pilot burner lights then operate normally after flame signal stabilizes..	Check the following: 1. Gas supply. 2. Pilot burner flame. 3. Spark/flame sense wiring. 4. Flame sense electrode contaminated or out of position. 5. Pilot burner ground. 6. Ignition module malfunction.
OFF	No pilot flame or flame sense signal below minimum for ignition system operation. Pilot burner spark is good.	Check the following: 1. Gas supply. 2. Pilot burner flame. 3. Spark/flame sense wiring. 4. Flame sense electrode contaminated or out of position. 5. Pilot burner ground. 6. Ignition module malfunction.

IGNITION SYSTEM STATUS LED CODES (GREEN) - PART NO. 857207-1 SINGLE TRY LOCKOUT IGNITION MODULE			
LED Flash Code	Indicates	System Action	Possible Causes
OFF	No Call for Heat	None	None
Fast Flash	Startup - Pilot flame sense calibration	Flame sense calibration automatically occurs immediately after pilot lights.	None
Heartbeat	Normal operation	None	None
3	Restart ignition trial - Pilot flame failed while main burner on	Trial for ignition auto re-starts. Flash code will remain through the ignition trial until pilot flame is proved.	If pilot burner fails to light on next trial for ignition - check: 1. Gas supply. 2. Pilot burner. 3. Spark/flame sense wiring. 4. Flame sense electrode contaminated or out of position. 5. Pilot burner ground.
4	Pilot flame sensed out of sequence	If ignition system self corrects within 10 seconds, ignition module returns to normal operation. If flame sense out of sequence continues, module changes to Flash Code 6+4.	1. Check pilot burner. A. If pilot flame present, replace gas valve. If no pilot flame, cycle Call for Heat, or power. B. If error repeats (continual or intermittent), replace ignition module.
7	Pilot flame sense leakage to ground	Module will not proceed to trial for ignition. When fault is corrected, module resumes trial for ignition, after a one minute delay.	1. Check spark/flame sense wiring. 2. Check flame sense electrode position. 3. Check flame sense electrode ceramic for cracks.

IGNITION SYSTEM STATUS LED CODES (GREEN) - PART NO. 857207-1 SINGLE TRY LOCKOUT IGNITION MODULE			
LED Flash Code	Indicates	System Action	Possible Causes
8	Low voltage to ignition module - Below 15.5 VAC	Module will not proceed to trial for ignition. When fault is corrected, module resumes trial for ignition, after a one minute delay.	1. Check voltage to ignition module during trial for ignition. 2. Check supply voltage to machine.
6+2	Lockout - Failed 90 second trial for ignition	Remains in lockout until power is cycled.	If pilot burner fails to light on next trial for ignition - check: 1. Gas supply. 2. Pilot burner. 3. Spark/flame sense wiring. 4. Flame sense electrode contaminated or out of position. 5. Pilot burner ground.
6+3	Lockout - More than 5 pilot flame failures while main burner was on during the same Call for Heat.	Remains in lockout until power is cycled.	If pilot burner fails to light on next trial for ignition - check: 1. Gas supply. 2. Pilot burner. 3. Spark/flame sense wiring. 4. Flame sense electrode contaminated or out of position. 5. Pilot burner ground.
6+4	Flame sensed out of sequence - longer than 10 seconds	When pilot flame is no longer sensed (pilot out), the ignition module enters soft lockout. Flash code continues. Module auto resets from soft lockout after one hour and restarts trail for ignition.	1. Check pilot burner. A. If pilot flame present, replace gas valve. If no pilot flame, cycle Call for Heat, or power. B. If error repeats (continual or intermittent), replace ignition module.
ON	Soft lockout due to error during self check	Ignition module auto resets from soft lockout after one hour and restarts trail for ignition.	1. Cycle Call for Heat, or power to reset. If error repeats, replace ignition module.

**FRYMATE (DUMP STATION)
WITH OPTIONAL HEATER**

SYMPTOM	POSSIBLE CAUSES
No heat.	<ol style="list-style-type: none"> 1. Unplugged. 2. Power switch off or inoperative. 3. Main circuit breaker off or open. 4. Malfunctioning heater assembly.

KLEENSCREEN FILTERING SYSTEM

SYMPTOM	POSSIBLE CAUSES
Shortening not filtering, pump motor is energized.	<ol style="list-style-type: none"> 1. Filter screen plugged. 2. Clog in filter system lines. <p>NOTE: If using solid shortening, when all filtered shortening is returned to the fry tank and filter power switch is off, open the filter drawer approximately one inch. Allow the remaining shortening in the line to drain into the filter tank to prevent possible clogging after the shortening cools and solidifies. Close the filter drawer when complete.</p> <ol style="list-style-type: none"> 3. Shortening below 300°F to thick. 4. R2 fill relay N.C. contacts are open. 5. Fill solenoid valve malfunction. 6. Interconnecting wiring malfunction. 7. Pump is inoperative.
Shortening not discarding, pump motor energized.	<ol style="list-style-type: none"> 1. Filter screen plugged. 2. Clog in filter system lines. <p>NOTE: If using solid shortening, when all filtered shortening is returned to the fry tank and filter power switch is off, open the filter drawer approximately one inch. Allow the remaining shortening in the line to drain into the filter tank to prevent possible clogging after the shortening cools and solidifies. Close the filter drawer when complete.</p> <ol style="list-style-type: none"> 3. Shortening below 300°F to thick. 4. Discard valve switch malfunction (N.O. contacts not closing to energize R2 fill relay coil). 5. R2 fill relay malfunction (contacts remain closed). <p>NOTE: The fill solenoid valve should not be energized during discard operation so that shortening will flow thru manual discard valve only.</p> <ol style="list-style-type: none"> 6. Discard valve mechanical malfunction. 7. Discard hose connection not fully engaged. 8. Pump is inoperative.
Pump motor is not energized to circulate shortening thru filtering system.	<ol style="list-style-type: none"> 1. Filter switch on cooking controls not turned on. 2. Pump needs reset. (Reset button located on pump) 3. R1 pump motor relay malfunction. 4. Cooking control malfunction. 5. Interconnecting wiring malfunction. 6. Pump motor inoperative.
Pump motor is not energized to discard shortening.	<ol style="list-style-type: none"> 1. Filter switch on cooking controls not turned on. 2. Pump needs reset. (Reset button located on pump) 3. Discard handle (yellow) not extended. 4. R1 pump motor relay malfunction. 5. Cooking control malfunction. 6. Interconnecting wiring malfunction. 7. Pump motor inoperative.