

## ERA & EBD SERIES ELECTRIC FRYERS WITH KLEENSCREEN PLUS® FILTRATION SYSTEMS



**2ER50AF KLEENSCREEN FRYER BATTERY**

MODEL	ML	MODEL	ML
1ER50A	136730	2XER50AF	136747
1E50BD	136730	2XE50BDF	136747
1ER50AF	136799	2XER85AF	136748
1E50BDF	136799	2XE85BDF	136748
1ER85A	136740	3ER50AF	136743
1E85BD	136740	3E50BDF	136743
1ER85AF	136802	3ER85AF	136744
1E85BDF	136802	3E85BDF	136744
2ER50AF	136741	4ER50AF	136745
2E50BDF	136741	4E50BDF	136745
2ER85AF	136742	4ER85AF	136746
2E85BDF	136742	4E85BDF	136746

This Manual is prepared for the use of trained Vulcan Service Technicians and should not be used by those not properly qualified.

This manual is not intended to be all encompassing. If you have not attended a Vulcan Service School for this product, you should read, in its entirety, the repair procedure you wish to perform to determine if you have the necessary tools, instruments and skills required to perform the procedure. Procedures for which you do not have the necessary tools, instruments and skills should be performed by a trained Vulcan Service Technician.

The reproduction, transfer, sale or other use of this Manual, without the express written consent of Vulcan, is prohibited.

This manual has been provided to you by ITW Food Equipment Group LLC ("ITW FEG") without charge and remains the property of ITW FEG, and by accepting this manual you agree that you will return it to ITW FEG promptly upon its request for such return at any time in the future.

For additional information on Vulcan-Hart Company or to locate an authorized parts and service provider in your area, visit our website at [www.vulcanhart.com](http://www.vulcanhart.com).

# TABLE OF CONTENTS

GENERAL .....	3
Introduction .....	3
Single Floor Model Fryers .....	3
Kleenscreen Filtration System .....	4
Specifications .....	4
Tools .....	4
REMOVAL AND REPLACEMENT OF PARTS .....	5
Covers and Panels .....	5
Cooking Controls .....	6
Discard Valve Switch (Kleenscreen Fryers Only) .....	6
Temperature Probe .....	6
High Limit Thermostat .....	7
Electrical Components .....	8
Circuit Breaker/ Supply Box Components .....	8
Fill Solenoid Valve (Kleenscreen Fryers Only) .....	9
Heating Elements .....	9
Lift Assist Springs .....	10
Tilt Switch .....	11
Pump and Motor (Kleenscreen Fryers Only) .....	12
SERVICE PROCEDURES AND ADJUSTMENTS .....	13
Temperature Probe Test .....	13
Cooking Control Calibration .....	14
Lift Assist Spring Adjustment .....	14
Heating Element Test .....	16
ELECTRICAL OPERATION .....	17
Component Function .....	17
Component Location .....	19
Sequence of Operation .....	20
Filtering System .....	20
Schematic Diagrams .....	22
208V & 240V Fryers Shown With KleenScreen Filtration System .....	22
480V Fryers Shown With KleenScreen Filtration System .....	23
Wiring Diagrams .....	24
208V & 240V (14, 17 kW) Fryers Shown With KleenScreen Filtration System .....	24
208V & 240V (24 kW) Fryers Shown With KleenScreen Filtration System .....	26
480V Fryers Shown With KleenScreen Filtration System .....	28
Frymate (Dump Station) .....	30
TROUBLESHOOTING .....	31
All Models .....	31
Frymate (Dump Station) with Optional Heater .....	31
Kleenscreen Filtering System .....	32

# GENERAL

## INTRODUCTION

This Service Manual covers specific service information related to the models listed on the front cover. ERA and EBD series electric fryers come equipped with behind-the-door solid state controls. The features and operation of the cooking controls are the same for both single floor model fryers and Kleenscreen battery fryers. All pictures and illustrations are of a 2ER50AF (17kW, 208V) unless otherwise noted.

## SINGLE FLOOR MODEL FRYERS

Fryers with the Filter-Ready option installed, use the Mobile Filter. For service information related to the Mobile filter refer to F24599 MOBILE FILTERS.

A GRO Frymate (dump station) can be configured in a battery with fryers 15 1/2 inches or 21 inches in width.

Model	KILOWATT EACH FRY TANK	FRYER WIDTH (INCHES) TOTAL SYSTEM	SHORTENING CAPACITY (LBS) EACH FRY TANK
1ER50A (1E50BD)	17	15.5	50
1ER50AF (1E50BDF)	17	15.5	50
1ER85A (1E85BD)	24	21.0	85
1ER85AF (1E85BDF)	24	21.0	85
2ER50AF (2E50BDF)	17	31.0	50
2ER85AF (2E85BDF)	24	42.0	85
2XER50AF (2XE50BDF)	17	31.0	50
2XER85AF (2XE85BDF)	24	42.0	85
3ER50AF (3E50BDF)	17	46.5	50
3ER85AF (3E85BDF)	24	63.0	85
4ER50AF (4E50BDF)	17	62.0	50
4ER85AF (4E85BDF)	24	84.0	85

## KLEENSCREEN FILTRATION SYSTEM

The Kleenscreen filtration system is integrated into the ERA & EBD Series fryer battery. The filter is housed in a pull-out drawer assembly at the base of the fryer. The filtering components in the drawer include a stainless steel filter tank, crumb-catch basket and a dual element mesh filter screen. With the filter drawer closed, a self-seating oil return line provides the path to return the filtered shortening to the fry tank.

This system is designed to provide a thorough and easy method to filter the shortening.

Some of the benefits include:

- Self-contained system eliminating the use of external filter equipment.
- Paperless filtering system.
- Easy to clean and low maintenance.

Kleenscreen fryer batteries are available in a minimum of two and a maximum of four fryer sections. The fryer size of each section is identical.

A GRO Frymate (dump station) can also be included as one or more of the sections.

## SPECIFICATIONS

MODEL	KW PER FRYER SECTION	AMPS - EACH FRYER SECTION (3 PHASE/ 60HZ)*		
		PER LINE		
		208V	240V	480V
ALL 50 LB CAPACITY FRYERS	14	39	34	17
	17	47	41	20
ALL 85 LB CAPACITY FRYERS	24	67	58	29
NOTES:	* Amperage values in the table are nominal. Tolerance is +5/-10%.			

### Single Floor Model Fryers

- 208VAC, 240VAC or 480VAC (3 phase, 60HZ) to power the heating elements.

### Drawer Filter System

Separate electrical connections are required for each section of the battery.

- 208VAC, 240VAC or 480VAC (3 phase, 60HZ) to power the heating elements.

- On 208VAC and 240VAC models, a transformer provides power for the fryer controls and drawer filter system controls.
- On 480VAC models, a 120VAC connection is required for each fryer section.

## TOOLS

### Standard

- Standard set of hand tools.
- VOM with A/C current tester (any quality VOM with a sensitivity of at least 20,000 ohms per volt can be used).
- Digital Temperature tester (thermocouple type).

### Special

- Field service grounding kit (available locally).
- Burndy pin extraction tool RX2025 GE1; Newark Electronics Catalog Number 16F6666. Used for removing pin terminals on Burndy connectors.
- Clamp on type amp meter.

# REMOVAL AND REPLACEMENT OF PARTS

## COVERS AND PANELS



**⚠ WARNING** Disconnect the electrical power to the machine and follow lockout / tagout procedures. There may be multiple circuits. Be sure all circuits are disconnected.

### Electrical Components Access Panel

1. Remove screws at top of access panel and lower panel.



2. Lift from hinge then remove panel.
3. Reverse procedure to install.

### Element Head Cover

1. Drain shortening from fry tank.
2. Remove screws from rear of element head assembly.

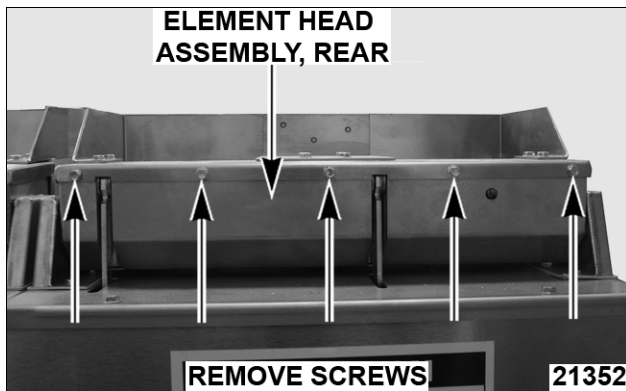

3. Raise heating elements and place 2x4 lumber under them for support.

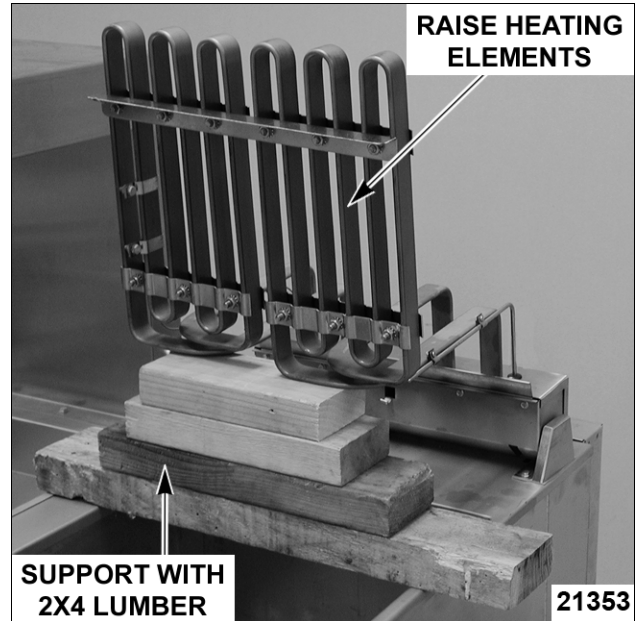

4. Remove screws from the bottom of element head assembly.

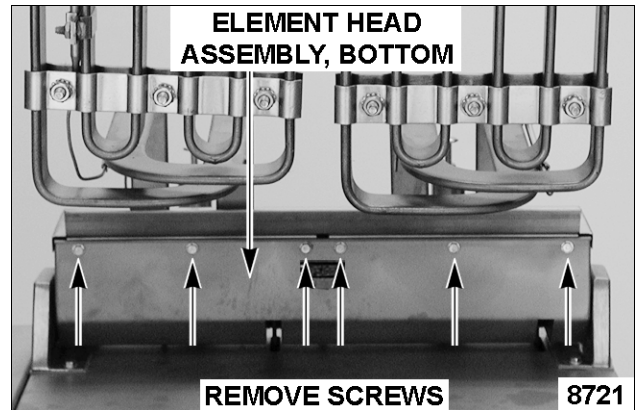

5. Grasp heating elements and remove 2x4 lumber. Lift the elements and pull toward rear of fryer. Head cover will separate from element head base.

- A. Lower the heating elements and place them in fry tank.

**NOTE:** Heating elements remain attached to element head cover.

6. Reverse procedure to install.

## COOKING CONTROLS



**⚠ WARNING** Disconnect the electrical power to the machine and follow lockout / tagout procedures. There may be multiple circuits. Be sure all circuits are disconnected.

**NOTICE** Certain components in this system are subject to damage by electrostatic discharge during field repairs. A field service grounding kit is available to prevent damage. The field service grounding kit must be used anytime the control board is handled.

1. Open fryer section door(s).
2. Remove electrical connection to cooking controls.

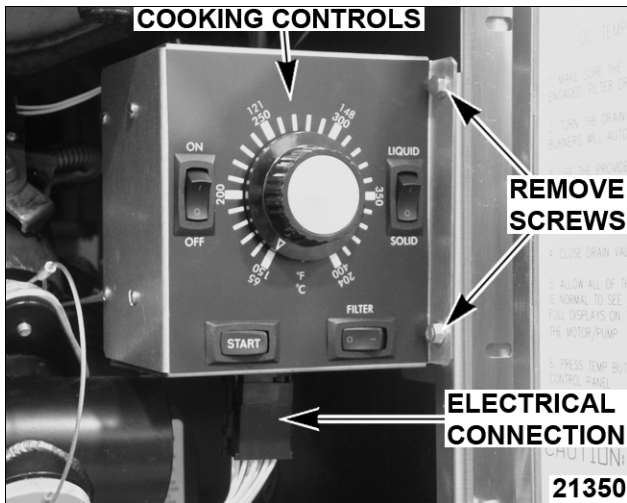

3. Remove screws securing controls.
4. Remove cooking control cover.
5. Disconnect lead wires from the component being replaced then remove from control box.

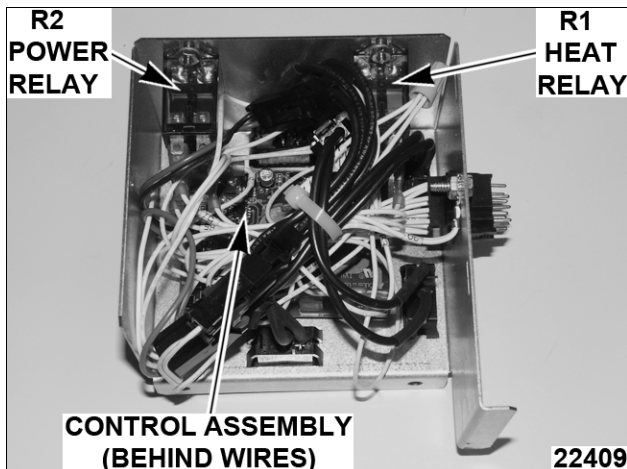

6. Reverse procedure to install and check for proper operation.

## DISCARD VALVE SWITCH (KLEENSCREEN FRYERS ONLY)



**⚠ WARNING** Disconnect the electrical power to the machine and follow lockout / tagout procedures. There may be multiple circuits. Be sure all circuits are disconnected.

1. Open the door to the fryer section being serviced.
2. Disconnect lead wire connector.
3. Remove switch mounting screws.

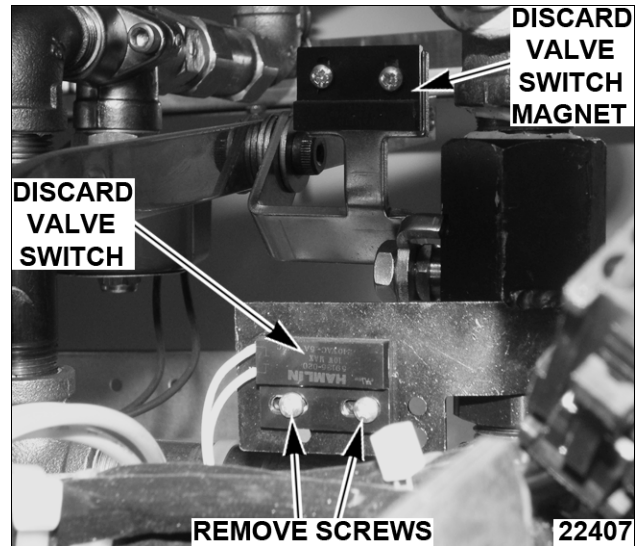

4. Remove discard valve switch.
5. Reverse procedure to install and check for proper operation.

**NOTE:** Switches are not adjustable.

## TEMPERATURE PROBE



**⚠ WARNING** Disconnect the electrical power to the machine and follow lockout / tagout procedures. There may be multiple circuits. Be sure all circuits are disconnected.

**NOTICE** Do not sharply bend and kink, or clamp down on the capillary tube or damage may occur.

1. Raise heating elements.
2. Remove clamps from temperature probe.

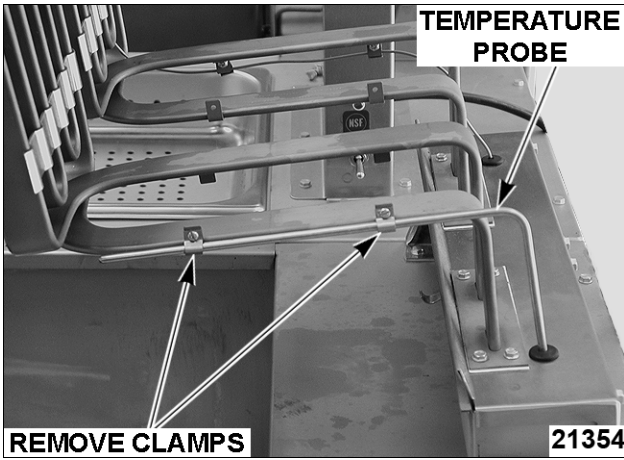

3. Remove element head cover as outlined under COVERS AND PANELS.
4. Disconnect temperature probe lead wires.

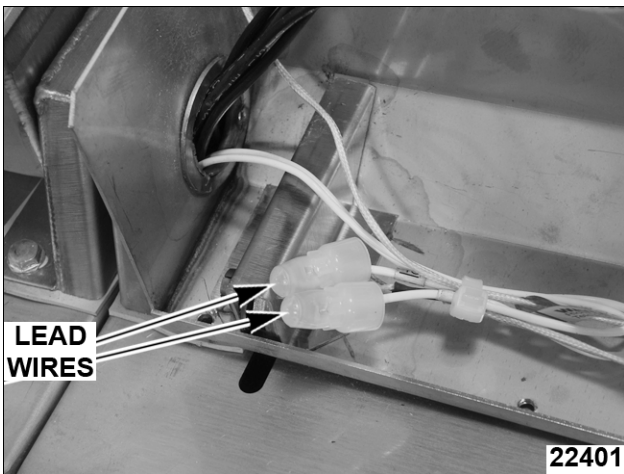

5. Remove temperature probe from the element head.
6. Reverse procedure to install.

**NOTE:** When installing, ensure grommet remains in place when inserting temperature probe thru the grommet in the element head.

7. Check cooking control calibration as outlined in COOKING CONTROL CALIBRATION under SERVICE PROCEDURES AND ADJUSTMENTS.

## HIGH LIMIT THERMOSTAT



**WARNING** Disconnect the electrical power to the machine and follow lockout / tagout procedures. There may be multiple circuits. Be sure all circuits are disconnected.

**NOTICE** Do not sharply bend and kink, or clamp down on the capillary tube or damage may occur.

1. Raise heating elements.

2. Loosen clamps securing capillary tube and bulb to element.

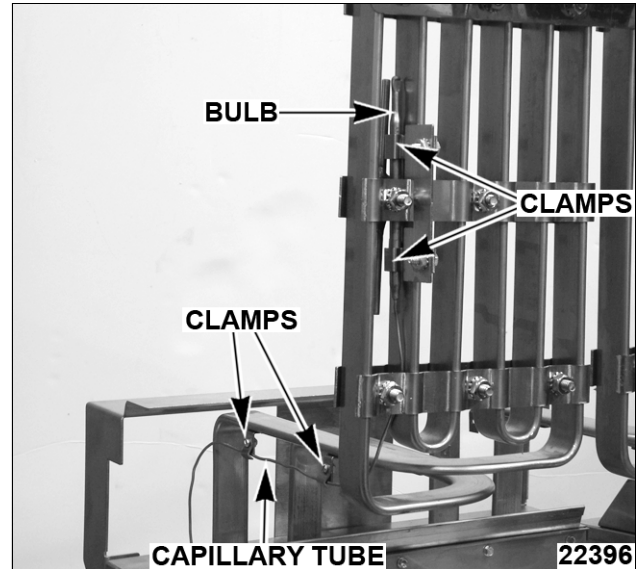

3. Remove element head cover as outlined under COVERS AND PANELS.
4. Remove high limit from mounting bracket.

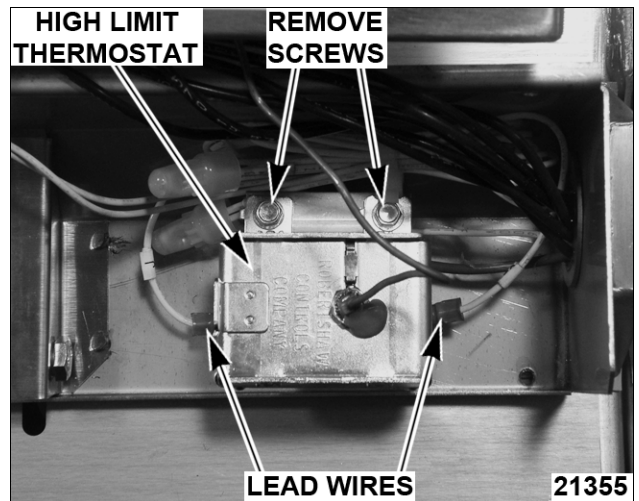

5. Disconnect high limit lead wires.
6. Remove grommet from the element head assembly.
7. Remove the bulb, capillary tube and high limit from the element head assembly.
8. Reverse procedure to install.
  - A. Slide grommet onto capillary tube then insert grommet into the capillary tube thru hole in the element head.
  - B. Move element lead wires clear of high limit when installing.

## ELECTRICAL COMPONENTS



**⚠ WARNING** Disconnect the electrical power to the machine and follow lockout / tagout procedures. There may be multiple circuits. Be sure all circuits are disconnected.

**NOTICE** Certain components in this system are subject to damage by electrostatic discharge during field repairs. A field service grounding kit is available to prevent damage. The field service grounding kit must be used anytime the control board is handled.

1. Open electrical component access panel.



2. Disconnect lead wires then remove the component being replaced.

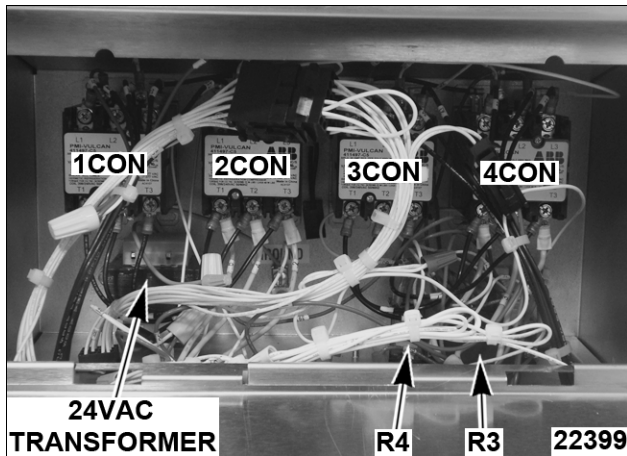

3. Reverse procedure to install the replacement component and check for proper operation.

## CIRCUIT BREAKER/ SUPPLY BOX COMPONENTS



**⚠ WARNING** Disconnect the electrical power to the machine and follow lockout / tagout procedures. There may be multiple circuits. Be sure all circuits are disconnected.

**NOTICE** Certain components in this system are subject to damage by electrostatic discharge during field repairs. A field service grounding kit is available to prevent damage. The field service grounding kit must be used anytime the control board is handled.

1. Remove screw and circuit breaker/ supply box cover.

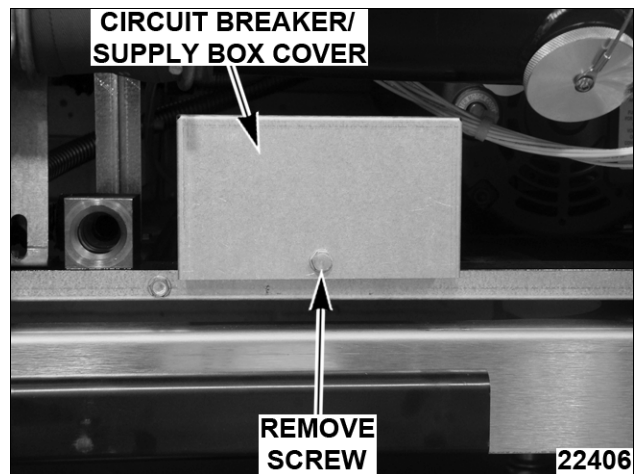

2. Disconnect lead wires then remove the component being replaced.

**NOTE:** Supply box will contain a circuit breaker on 24kW 208-240V units.

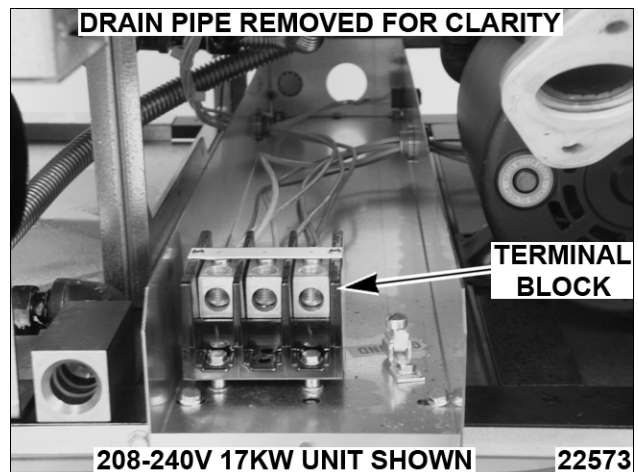

3. Reverse procedure to install the replacement component and check for proper operation.



## FILL SOLENOID VALVE (KLEENSCREEN FRYERS ONLY)



**⚠ WARNING** Disconnect the electrical power to the machine and follow lockout / tagout procedures. There may be multiple circuits. Be sure all circuits are disconnected.

1. Disconnect swivel pipe fitting at rear of fry tank.

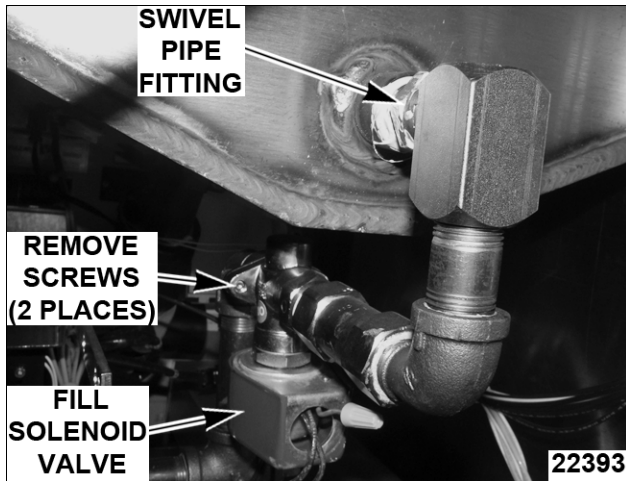

2. Disconnect fill solenoid valve lead wire connector from below control panel.
3. Remove screws (2) securing the solenoid valve body flange to pipe tee then remove the assembly from fryer.
  - A. Remove pipe fittings from solenoid valve and install on replacement valve.
4. Reverse procedure to install and check for proper operation.

## HEATING ELEMENTS



**⚠ WARNING** Disconnect the electrical power to the machine and follow lockout / tagout procedures. There may be multiple circuits. Be sure all circuits are disconnected.

**NOTICE** Do not sharply bend and kink, or clamp down on the capillary tube or damage may occur.

1. Raise heating elements.
  - A. If replacing left heating element, loosen high limit bulb and capillary tube clamps. Remove high limit bulb and capillary tube from clamps then position away from element.

- B. If replacing right heating element, remove temperature probe clamps and position temperature probe away from element.

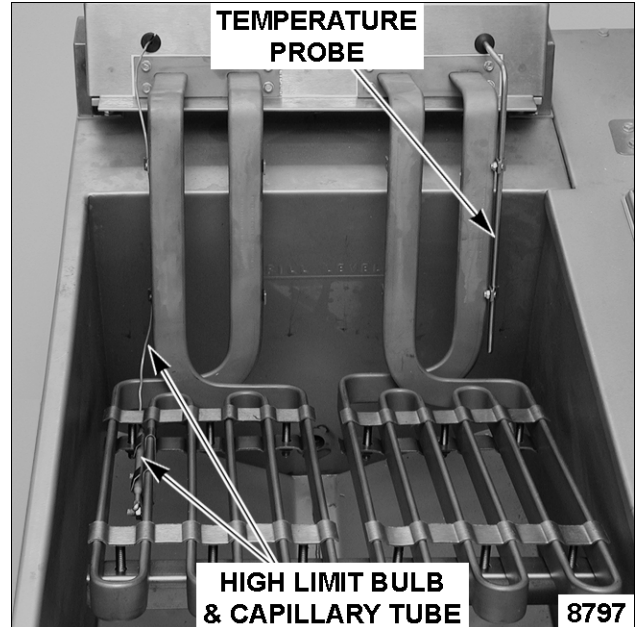

**NOTE:** When installing high limit, route the capillary tube and center the bulb between the clamps before tightening.

2. Remove element assembly clamps.

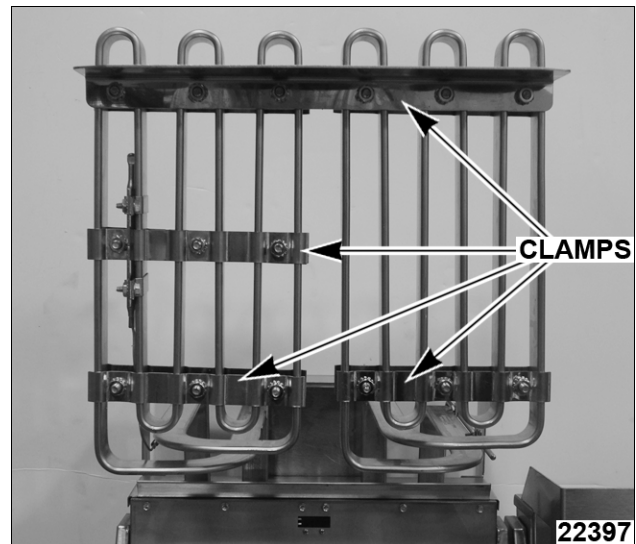

3. Remove element head cover as outlined under COVERS AND PANELS.
4. Disconnect heating element lead wires.
 

**NOTE:** Each heating element assembly contains three individual elements (six lead wire connections total).
5. Remove screws from heating element mounting bracket and remove heating element.

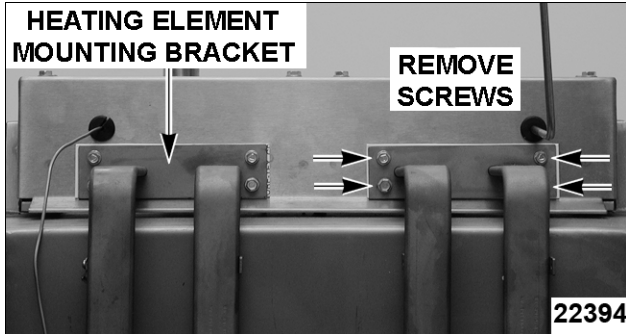

6. Reverse procedure to install.

### LIFT ASSIST SPRINGS



**⚠ WARNING** Disconnect the electrical power to the machine and follow lockout / tagout procedures. There may be multiple circuits. Be sure all circuits are disconnected.

**NOTE:** If one spring breaks, replace both springs.

1. Raise heating elements and place 2x4 lumber under them for support. Heating elements are to remain upright.

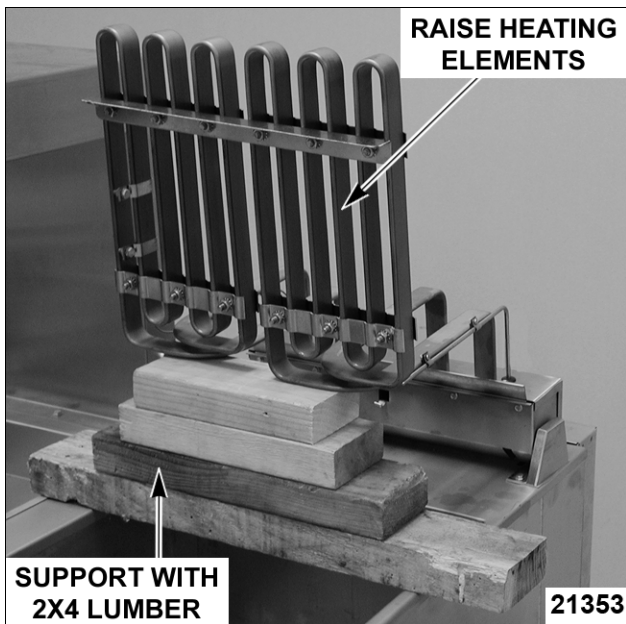

2. Loosen all eye bolt mounting nuts to release tension on springs.

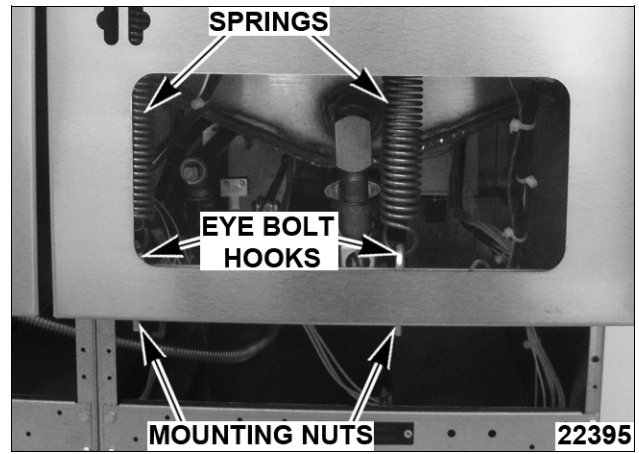

3. Remove lift assist springs from the eye bolt hooks.
4. Remove lift assist springs from the hangers.
5. To install springs:
  - A. Attach spring hook to hanger thru rear door opening.
  - B. Attach spring hook to eye bolt and tighten eye bolt mounting nut.

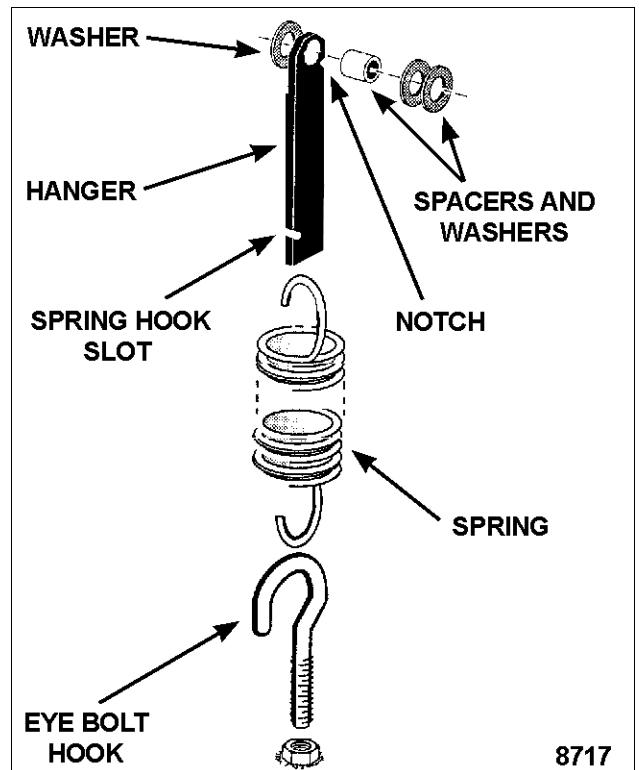

- C. Remove 2x4 lumber and lower heating elements.
6. Adjust spring tension as outlined under LIFT ASSIST SPRING ADJUSTMENT in SERVICE PROCEDURES AND ADJUSTMENTS.

## TILT SWITCH



**⚠ WARNING** Disconnect the electrical power to the machine and follow lockout / tagout procedures. There may be multiple circuits. Be sure all circuits are disconnected.

1. Remove element head cover as outlined under COVERS AND PANELS.
2. Lower heating elements.
3. Disconnect lead wires from tilt switch.
4. Remove tilt switch from element head.

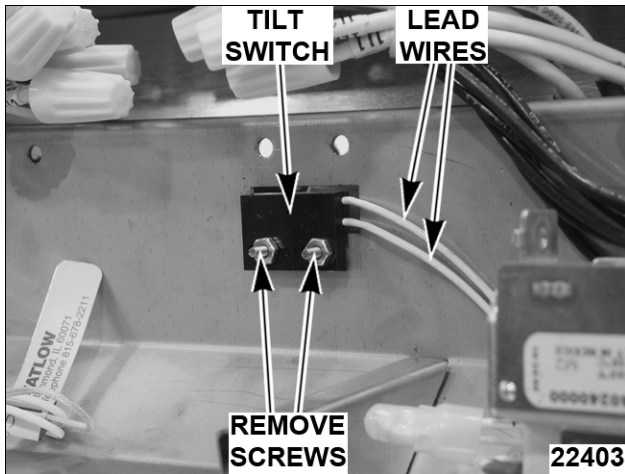

REAR VIEW SHOWN, ELEMENTS LOWERED

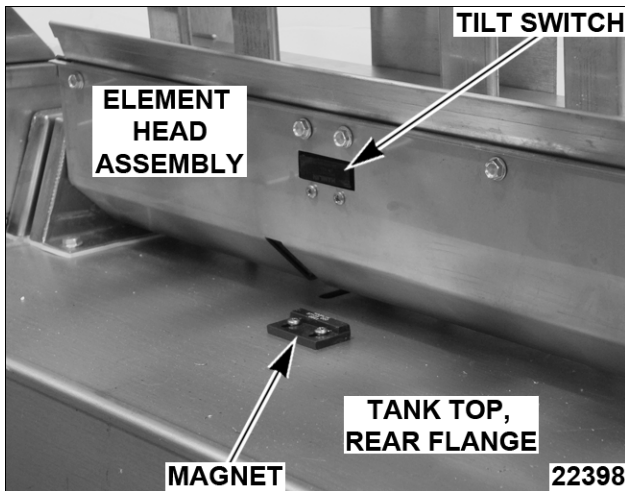

FRONT VIEW SHOWN, ELEMENTS RAISED

5. Reverse procedure to install and check for proper operation.

## PUMP AND MOTOR (KLEENSCREEN FRYERS ONLY)



**⚠ WARNING** Disconnect the electrical power to the machine and follow lockout / tagout procedures. There may be multiple circuits. Be sure all circuits are disconnected.

- A. Remove pipe fittings from the pump and install on replacement pump.
8. Reverse procedure to install and check for proper operation.

1. Drain filter tank of shortening.
2. Open the fryer section doors above the filter tank drawer.
3. Pull filter drawer out, remove filter tank assembly and push the tank support arms back into place under the fryer.
4. Remove splash guard from base frame.

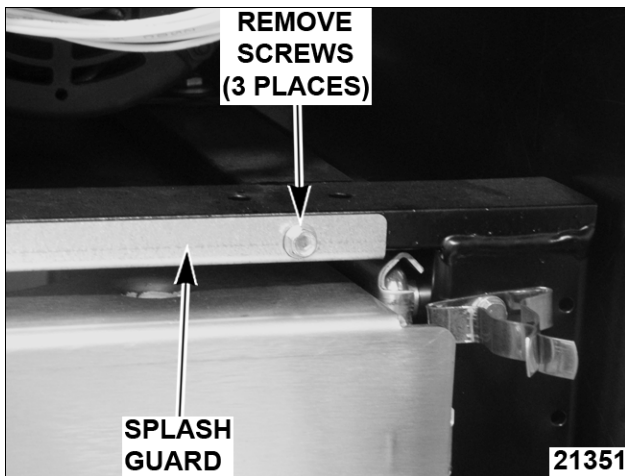

5. Disconnect pump motor lead wire connector.
6. From underneath the fryer:
  - A. Disconnect flexible line fittings from pump.
7. Remove pump motor assembly from fryer.

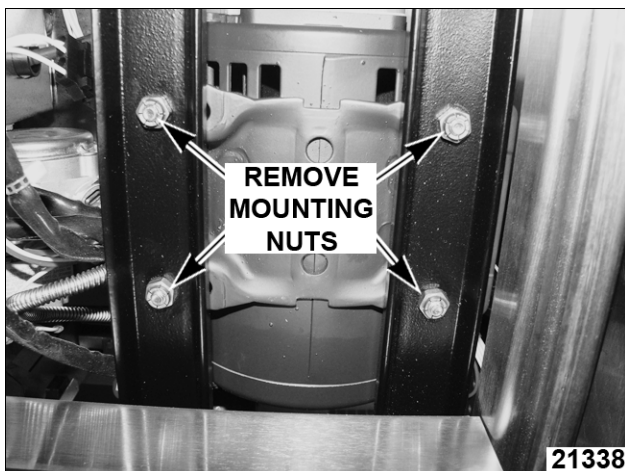

# SERVICE PROCEDURES AND ADJUSTMENTS

**⚠ WARNING** Certain procedures in this section require electrical test or measurements while power is applied to the machine. Exercise extreme caution at all times. If test points are not easily accessible, disconnect power and follow lockout / tagout procedures, attach test equipment and reapply power to test.

## TEMPERATURE PROBE TEST

The temperature probe is an RTD (resistance temperature device) of the thermistor type. As temperature increases the resistance value decreases.

### Probe Fault

If a temperature probe fault occurs, red diagnostic LED on back of control assembly (inside control box cover) will flash. The heat demand outputs are de-activated.

This will continue until the fault clears, power is cycled or problem resolved.

A temperature probe fault can be caused by a lead wire break or a lead short.

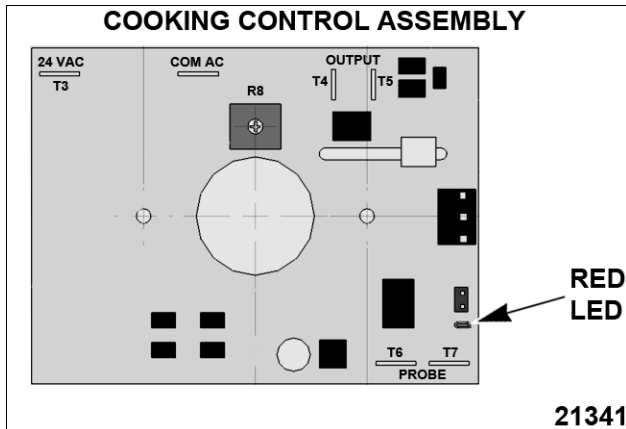

### To Check:

1. Turn power switch off.
2. Disconnect cooking control connector.



3. Test the probe using a VOM to measure resistance. Connect the meter leads to pins 4 & 5 on the male connector.
  - A. If the measured resistance values are within the allowable range, the probe is functioning properly. Reverse procedure to install.
  - B. If the measured resistance values are outside the allowable range, install a replacement probe and check for proper operation.

Temperature (°F)	Resistance (Ω)
77	90,000 - 110,000
212	5,016 - 6,130
275	1,804 - 2,204
300	1,254 - 1,534
350	646 - 790
392	391 - 478

## COOKING CONTROL CALIBRATION

1. Verify condition of temperature probe as outlined under TEMPERATURE PROBE TEST.
2. Check the level of shortening in fry tank. The level must be between the MIN & MAX fill lines before proceeding.
3. Place clamp on type amp meter around any yellow lead wire of 2CON or 4CON.

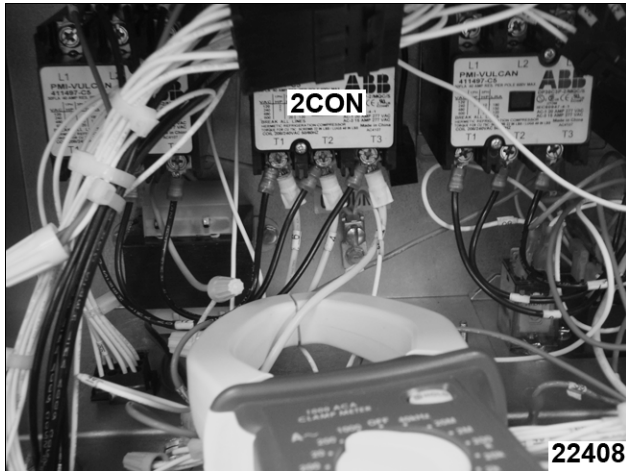

4. Allow shortening to cool below 300°F.
5. Place a thermocouple in the geometric center of the fry tank one inch below the shortening surface.
6. Set the cooking control to 350°F and turn the fryer on.
7. Monitor the current as it cycles on and off.

**NOTE:** Stir shortening to eliminate any cold zones.

- A. Allow heat to cycle three times to stabilize shortening temperature.
- B. Record meter reading from thermocouple when the current cycles off and on for at least two complete heating cycles.

8. Calculate the average temperature by adding the temperature reading when the heat goes off to the temperature reading when the heat comes on & divide this answer by 2.

[ Temp. (Heat off) + Temp. (Heat on) ] ÷ 2 = Average Temp.

Example: 360° + 340° ÷ 2 = 350°F.

The average temperature should be 350°F (± 5°F).

- A. If the average temperature reading is within tolerance, cooking control is properly calibrated.

- B. If the average temperature reading is out of tolerance, loosen set screw to remove temperature knob and adjust calibration potentiometer.

**NOTE:** Ensure that the shaft and knob position does not change when loosening set screw and removing temperature knob, as this could affect calibration.

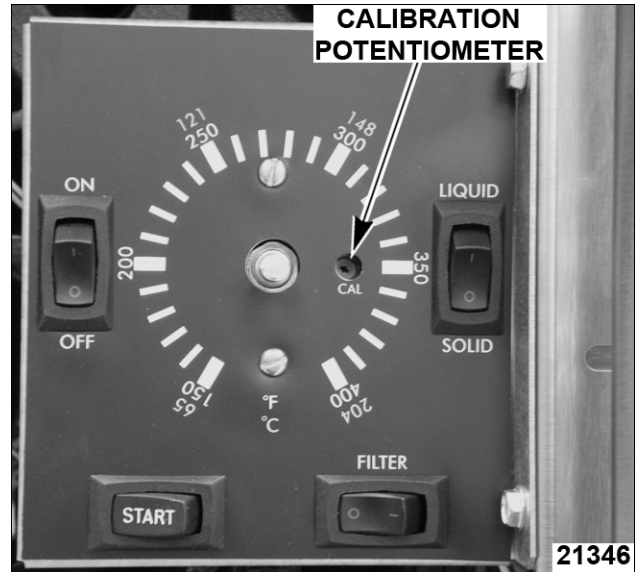

- 1) Adjust calibration potentiometer clockwise to increase temperature, and counterclockwise to decrease temperature.
  - a. If over 25° of adjustment is necessary, replace cooking control.
9. Repeat the average temperature calculation for up to three attempts. Allow the cooking control to cycle at least two times between adjustments before performing the calculation.
10. If calibration is unsuccessful, the cooking control may be malfunctioning and cannot be adjusted properly. Install a replacement cooking control and check calibration.

## LIFT ASSIST SPRING ADJUSTMENT

1. Turn power switch off.
2. Check spring tension:
  - A. Raise heating elements to the full up position. Elements should remain in place.
  - B. Lower heating elements to the full down position. Elements should remain in place.
  - C. If the elements remain in place as described, then no adjustment is necessary. If the elements do not remain in place, continue with procedure for adjustment.

3. Lower heating elements to the down position.
4. Loosen stop nut on all eye bolts.

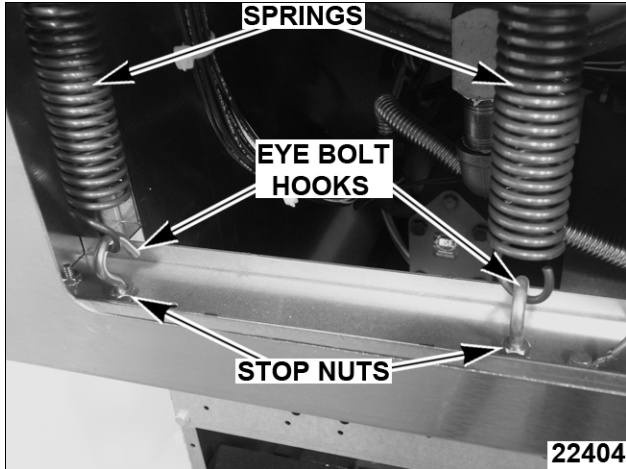

5. Adjust eye bolt mounting nuts as necessary, but equally on all springs to achieve the best spring tension to hold elements in place.

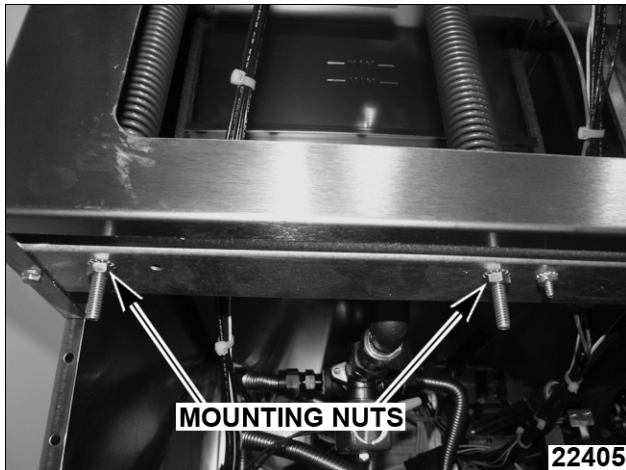

6. Perform spring tension check (step 2 above).
7. Repeat spring tension adjustment if necessary.
8. Tighten stop nut on all eye bolts.

**HEATING ELEMENT TEST**

VOLTAGE	TOTAL KW	AMPS PER ELEMENT	OHMS PER ELEMENT
208	14	11	18.4
	17	13.5	15.5
	24	19.2	10.8
240	14	9.6	25.1
	17	11.6	20.5
	24	16.7	14.4
480	14	4.8	100.1
	17	5.8	82.3
	21	7.3	65.8
	24	8.3	57.6

- NOTES:**
1. Values in the table are nominal. Tolerance is +5/-10%.
  2. Resistance values (ohms) are @ room temperature.
  3. There are 3 elements per firebar, 6 elements per tank.

1. Remove element head cover as outlined under **COVERS AND PANELS** in **REMOVAL AND REPLACEMENT OF PARTS**.

**NOTICE** Heating elements must remain submerged in shortening while performing this test or damage may occur.

2. Access heating element lead wire connections at wire nuts.
3. Re-connect power, turn power switch on and set cooking control to call for heat.
4. Measure voltage at heating element connections and verify against data plate voltage.
  - A. If voltage is incorrect, see ALL MODELS under **TROUBLESHOOTING**.
  - B. If voltage is correct, check current draw (amps) through the heating element lead wires. See table for proper values.

**NOTE:** This method is preferred over a resistance check when a clamp on type amp meter is available.

- 1) If current draw is correct then heating element is functioning properly.
- 2) If current draw is not correct, turn power switch off and disconnect power to the machine.
  - a. Install a replacement heating element.
  - b. Proceed to last step.

- C. If unable to check current draw, a resistance check may indicate a malfunctioning element. See table for proper values.
  - 1) Turn power switch off and disconnect power to the machine.
  - 2) Remove wire nuts from heating element lead wire connections and separate lead wires.
  - 3) Check resistance (ohms).
5. Check for proper operation.



# ELECTRICAL OPERATION

## COMPONENT FUNCTION

### FRYER CONTROLS

<b>Cooking Control</b> .....	Monitors and evaluates input signals to the control: Activates heat output signal to maintain shortening temperature; and activates filter output signal to power the fill solenoid valve.
<b>Transformer</b> .....	Supplies 24VAC to the cooking control circuit. Transformer is energized when power switch is turned on.
<b>Power Switch</b> .....	Supplies power to control circuit for fryer operation and filtering.
<b>Melt Select Switch</b> .....	Controls heating circuit operation during melt cycle based on type of shortening being used (liquid/ solid).
<b>High Limit Thermostat</b> .....	Prevents the shortening from reaching temperatures over 450°F. (Manual reset)
<b>Temperature Probe</b> .....	Senses temperature of shortening. Converts the temperature into a resistance which is monitored by the cooking control. The probe is an RTD (resistance temperature device) of the Thermistor type. As temperature increases the resistance value decreases.
<b>Drain Valve Interlock Switch (DVI)</b> .....	A magnetic reed switch mounted on the manual drain valve that supplies a drain valve position signal (open/closed) to the cooking control. When drain valve is open, the drain interlock input to the control is removed (magnetic reed switch contacts open). This prevents heating elements from being energized with the fry tank empty.
<b>Tilt Switch</b> .....	A magnetic reed switch (N.O.) mounted underneath the element head assembly. Remove power from 1CON and 3CON to de-energize the heating elements when the elements are raised.
<b>1CON, 3CON and 2CON, 4CON Contactors</b> .....	Supplies line voltage to heating elements.
<b>Heating Elements</b> .....	Produces heat that is transferred to the shortening.
<b>R1 Heat Relay</b> .....	Supplies power to 2CON and 4CON contactor coils.
<b>R2 Power Relay</b> .....	Supplies power to cooking control.

### KLEENSCREEN FILTER CONTROLS

- Fill Solenoid Valve** ..... When energized by filter switch, the solenoid valve opens to allow the flow of shortening thru filtering system.
- Pump Motor** ..... Operates pump to circulate shortening through filtering system.
- Start Switch** ..... Supplies start heating function to the temperature control at the beginning of a cooking cycle or after the vat has been filled from the filter process.
- Filter Switch** ..... Energizes pump motor to filter the shortening when switch is closed (valve handle extended). Filter power switch must be turned on.
- Discard Valve Switch** ..... A magnetic reed switch mounted on the mechanical discard valve that closes when discard valve handle is extended to discard the shortening. Prevents R4 solenoid relay N.C. contacts from supplying power to the fill solenoid valve when filter key is pressed.
- R3 Filter Relay** ..... Supplies power to pump motor and solenoid.
- R4 Solenoid Relay** ..... Removes power to solenoid if discard valve switch is operated.

**COMPONENT LOCATION**

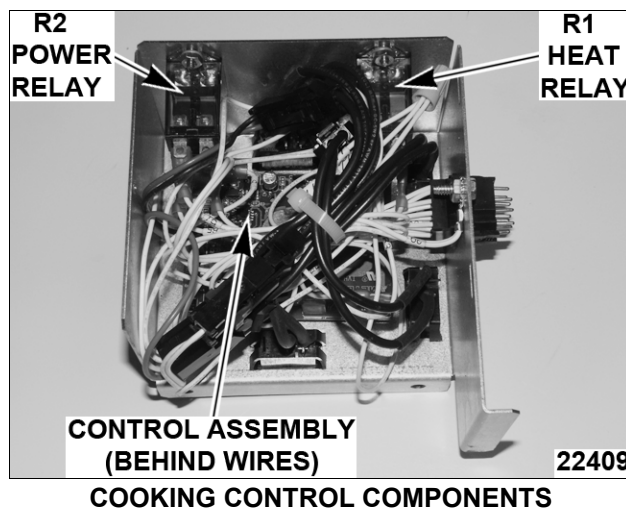
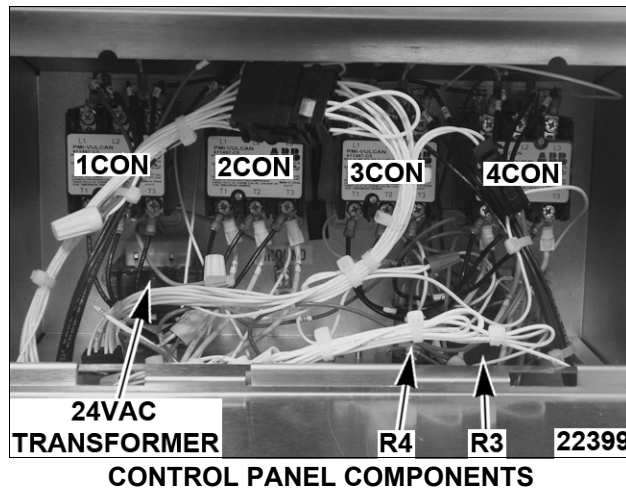
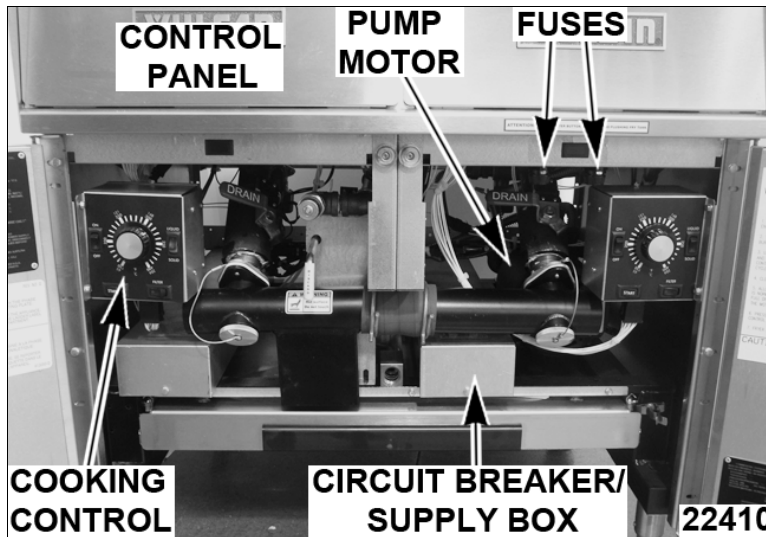

## SEQUENCE OF OPERATION

1. Conditions.
  - A. Fryer connected to correct supply voltage and is properly grounded. Separate connections are required for each section of the battery.
    - 1) 120/24VAC transformer energized.
  - B. Internal fryer circuit breaker ON (24kW, 208-240V units only).
  - C. Power switch off.
  - D. Shortening at proper level in fry tank and below last set point temperature used.
  - E. Cooking control is setup properly and ready to use.
  - F. Manual drain valve closed (drain valve interlock switch N.O. is closed).
  - G. Tilt switch contacts closed (N.O. - held closed with heating elements lowered).
  - H. High limit thermostat closed.
2. Turn power switch on.
  - A. Supply voltage energizes:
    - 1) 1CON and 3CON thru high limit thermostat and tilt switch.
    - 2) R2 power relay coil and R2 N.O. contacts close.
    - 3) Cooking control thru DVI switch.
3. Press start momentary switch.
  - A. If shortening temperature is below set point, J5 outputs 24VDC to R1 thru wire 56.
    - 1) R1 heat relay coil energized and R1 N.O. contacts close.
      - a. 2CON and 4CON are energized and heating elements are powered.
4. Shortening reaches set temperature.
  - A. Cooking control de-activates the heat demand output (24VDC) at J5. With power removed from J5, R1 is de-energized thru wire 56.
    - 1) 2CON and 4CON are de-energized and power is removed from heating elements.

5. Cooking control cycles heat output on shortening temperature until power switch is turned off, heating elements are raised or a high limit condition occurs.
  - A. If shortening reaches 460°F, the high limit thermostat opens, 1CON and 3CON are de-energized and power is removed from heating elements.
    - 1) 1CON and 3CON remain de-energized until the shortening temperature drops below 460°F, manual reset button is pressed and start button is actuated.

### Filtering System

The discard valve handle is connected to a mechanical valve and switch assembly to route the flow of shortening (electrically and mechanically) in the filtering system.

Refer to Installation & Operation manual for specific instructions on filtering.

1. Conditions
  - A. Fryer connected to correct supply voltage and is properly grounded.
  - B. Power switch to the fryer section off.
  - C. Shortening between 300°F and 350°F.
  - D. Filter drawer assembly installed properly.
  - E. Filter power switch off.
  - F. Discard valve handle (yellow) retracted.
    - 1) Discard valve switch N.O. contacts open. Mechanical discard valve closed.
2. Turn power switch on, to the fryer section to be filtered.
3. Set cooking control between 300°F (minimum) and 350°F (maximum).

**NOTE:** Shortening should not be filtered outside of this temperature range. At lower temperatures the shortening is thicker which may increase filtering time and place a greater load on the pump. At higher shortening temperatures, the pump seal life is decreased.

- A. Allow shortening to cycle at set temperature for approximately 10 minutes.

**NOTE:** If using solid shortening, once it has melted, stir the shortening to eliminate any solid shortening in cold zone of the fry tank.

4. Open the manual drain valve to the fryer section in need of and drain the shortening into filter tank. (Heat circuit will be disabled)

**NOTE:** If using solid shortening, allow hot shortening to stand in filter tank for approximately 6 minutes prior to filtering.

5. Turn filter power switch on.
  - A. R3 filter relay coil energized.
  - B. R3 N.O. contacts close.
    - 1) Power supplied to pump motor and fill solenoid.
6. Pump motor circulates shortening through filter and solenoid to tank until power is removed.
7. When filtering process is completed and the tank is full, turn off filtering switch.
  - A. Power is removed from pump motor and solenoid closes.

**NOTE:** If using solid shortening, when all filtered shortening is returned to the fry tank and filter power switch is off, open the filter drawer approximately one inch. Allow the remaining shortening in the line to drain into the filter tank to prevent possible clogging after the shortening cools and solidifies. Close the filter drawer when complete.

8. To restart the cooking process, press the start button.

### Discarding Shortening

The discard valve handle is connected to a mechanical valve and switch assembly to route the flow of shortening (electrically and mechanically) out discard hose.

Refer to Installation & Operation manual for specific instructions on draining.

1. Conditions
  - A. Fryer connected to correct supply voltage and is properly grounded.
  - B. Power switch to the fryer section off.
  - C. Shortening between 300°F and 350°F.
  - D. Filter drawer assembly installed properly.
  - E. Filter power switch off.
  - F. Discard valve handle (yellow) retracted.
    - 1) Discard valve switch N.O. contacts open. Mechanical discard valve closed.
2. Turn power switch on, to the fryer section to be drained.
3. Set cooking control between 300°F (minimum) and 350°F (maximum).

**NOTE:** Shortening should not be drained outside of this temperature range. At lower temperatures the shortening is thicker which may increase draining time and place a greater load on the pump. At higher

shortening temperatures, the pump seal life is decreased.

- A. Allow shortening to cycle at set temperature for approximately 10 minutes.

**NOTE:** If using solid shortening, once it has melted, stir the shortening to eliminate any solid shortening in cold zone of the fry tank.

4. Open the manual drain valve to the fryer section in need of discarding and drain the shortening into filter tank. (Heat circuit will be disabled)
 

**NOTE:** If using solid shortening, allow hot shortening to stand in filter tank for approximately 6 minutes prior to discarding.
5. Connect discard hose. Place other end of discard hose in appropriately-sized receptacle.
6. Pull out discard handle.
  - A. Discard switch N.O. contacts close.
  - B. R4 solenoid relay coil energized.
    - 1) R4 N.C. contacts open.
7. Turn filter power switch on.
  - A. R3 filter relay coil energized.
  - B. R3 N.O. contacts close.
    - 1) Power supplied to pump motor.
8. Pump motor circulates shortening out discard hose and into receptacle.

**NOTICE** If discard receptacle is not large enough to hold entire shortening amount, turn filter switch off to stop pump motor. Empty receptacle and resume discard operation by turning filter switch on.

9. When discard process is complete, turn off filter switch.
  - A. Power is removed from pump motor.
10. Push in discard handle.

**SCHEMATIC DIAGRAMS**

**208V & 240V Fryers Shown With KleenScreen Filtration System**

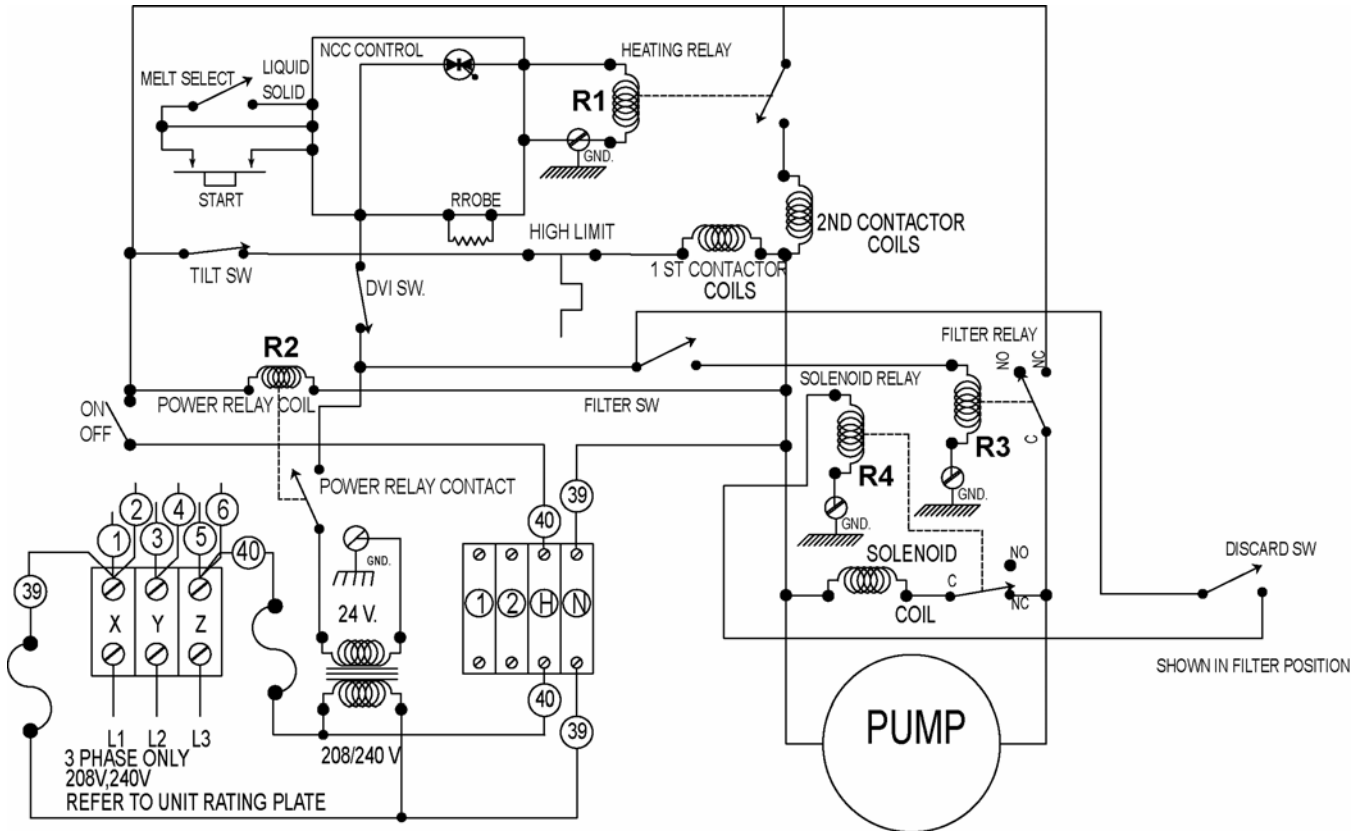

CHECK UNIT RATING  
PLATE FOR THIS UNIT'S  
KILOWATT POWER INPUT.

**208-240 VOLT PHASE LOAD**

TOTAL KW	KW/PHASE		
	X-Y	X-Z	Y-Z
24	8.0	8.0	8.0
17	5.6	5.6	5.6
14	4.6	4.6	4.6
AMPS PER LINE 208 VOLT			
	X	Y	Z
24	67	67	67
17	47	47	47
14	39	39	39
AMPS PER LINE 240 VOLT			
	X	Y	Z
24	58	58	58
17	41	41	41
14	34	34	34

**DERIVED FROM  
957331-2 REV C**

**AI 2858**

480V Fryers Shown With KleenScreen Filtration System

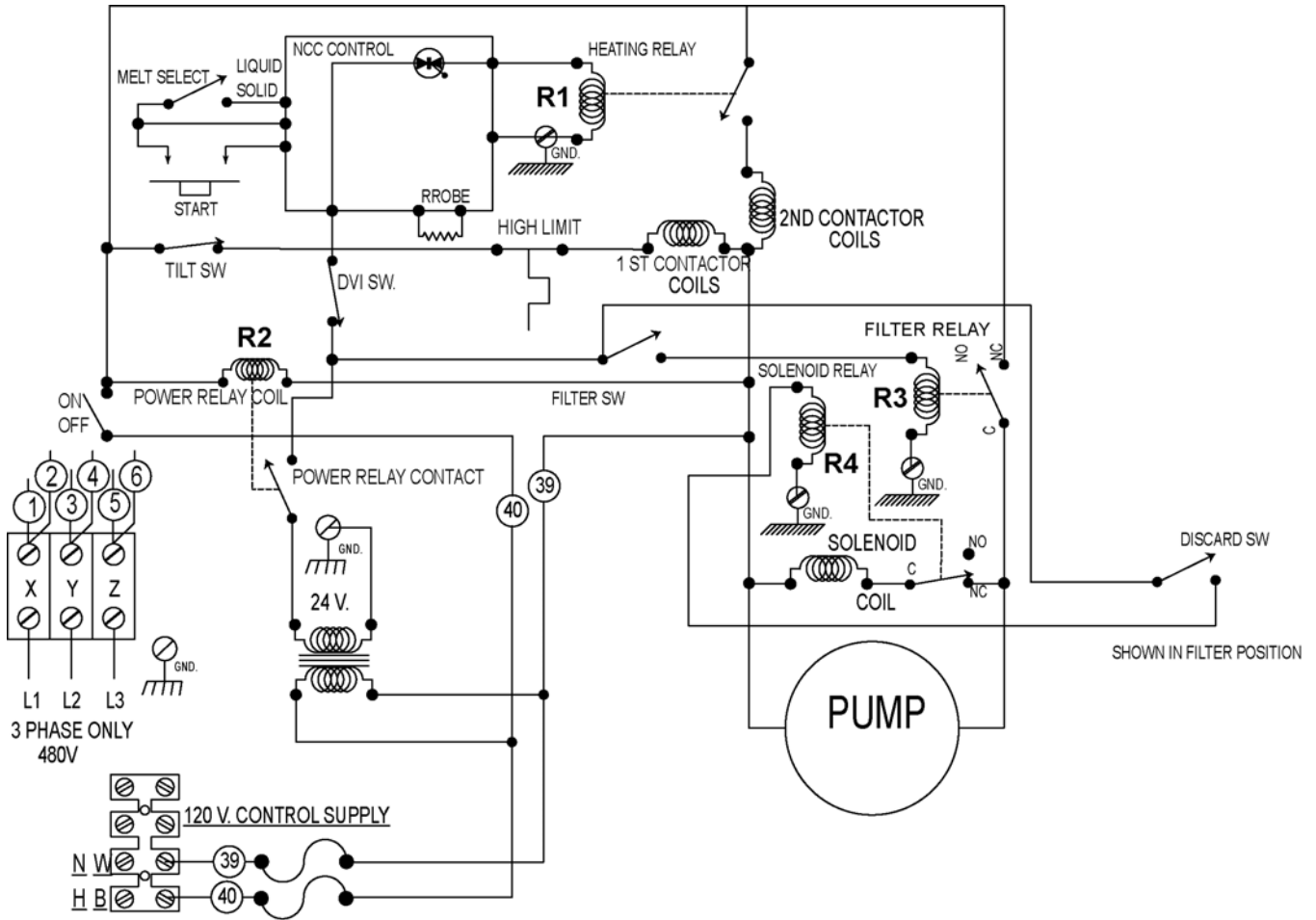

UNIT CONTAINS 2 SOURCES OF SUPPLY  
ENSURE BOTH ARE OFF BEFORE SERVICING

CHECK UNIT RATING  
 PLATE FOR THIS UNIT'S  
 KILOWATT POWER INPUT.

480 VOLT PHASE LOAD

TOTAL KW	KW/PHASE		
	X-Y	X-Z	Y-Z
24	8	8	8
17	5.66	5.66	5.66
14	4.66	4.66	4.66
AMPS PER LINE			
	X	Y	Z
24	29	29	29
17	20	20	20
14	17	17	17

DERIVED FROM  
 957332-2 REV C

AI 2859

**WIRING DIAGRAMS**

208V & 240V (14, 17 kW) Fryers Shown With KleenScreen Filtration System

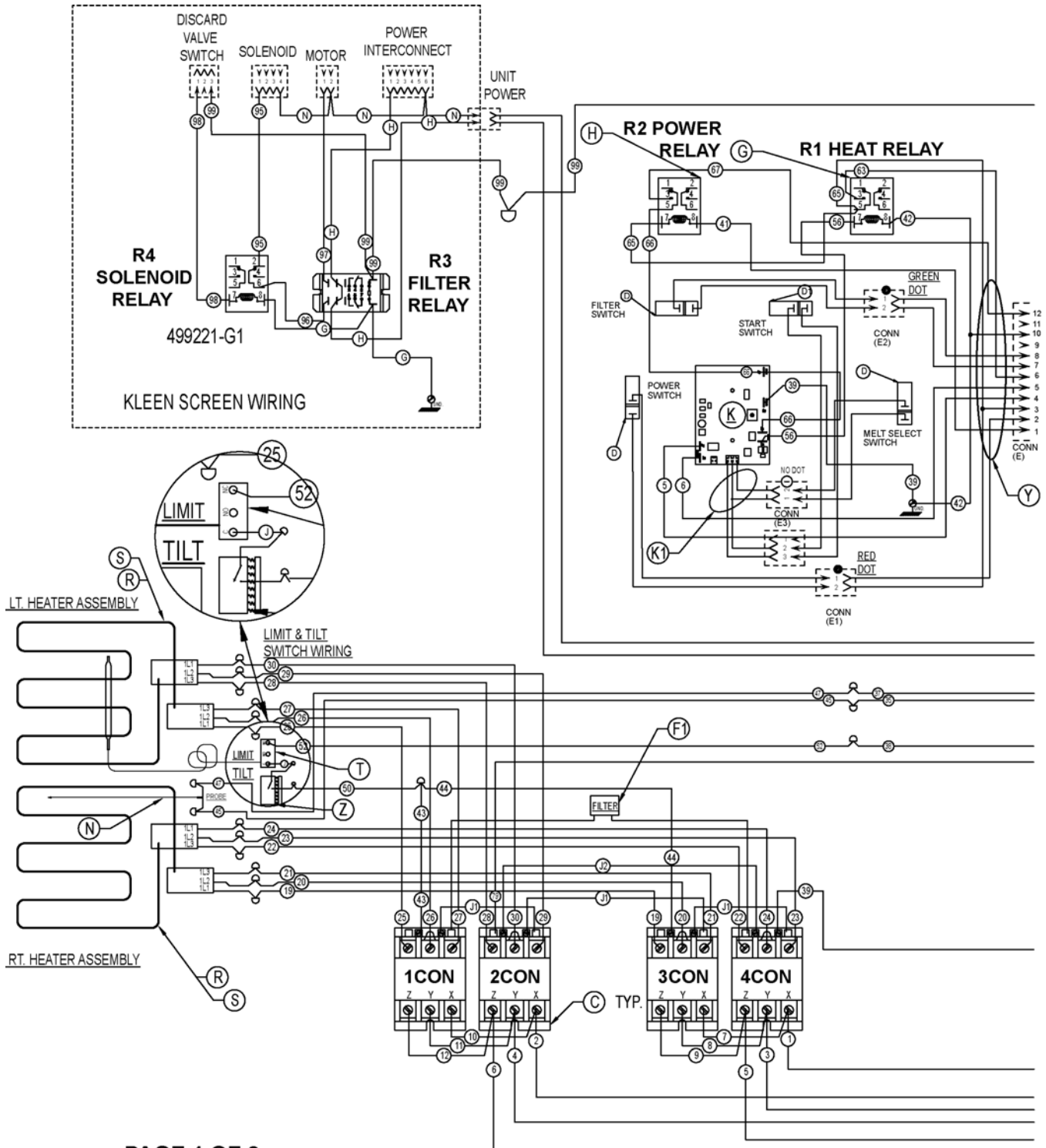

PAGE 1 OF 2  
SEE AI 2861

AI 2860



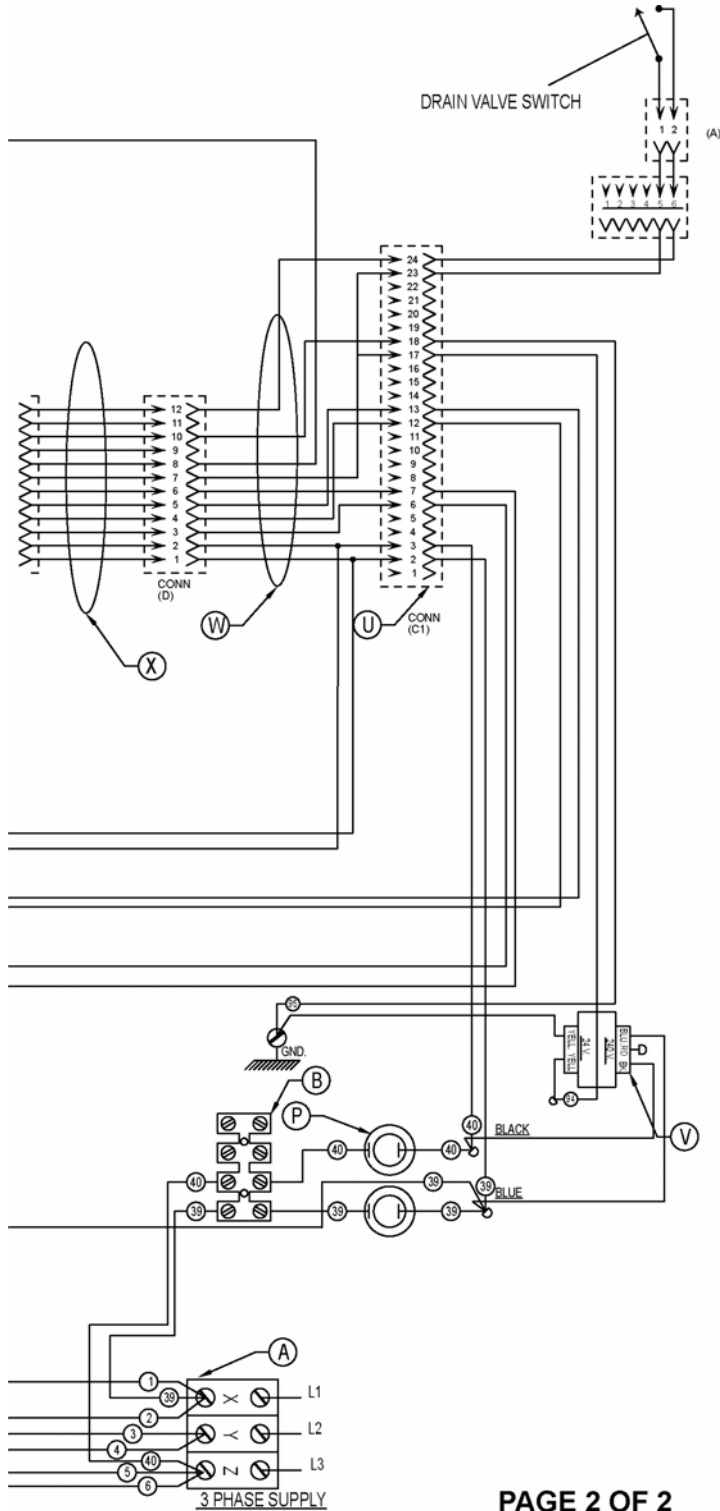

208-240 VOLT PHASE LOAD

TOTAL KW	KW/PHASE		
	X-Y	X-Z	Y-Z
17	5.6	5.6	5.6
14	4.6	4.6	4.6
AMPS PER LINE 208 VOLT			
	X	Y	Z
17	47	47	47
14	39	39	39
AMPS PER LINE 240 VOLT			
	X	Y	Z
17	41	41	41
14	34	34	34

1	1	F1	FILTER ASSEMBLY SINGLE	
1	1	Z	SWITCH, LIMIT	WIRED MAGNET
1	1	Y	HARNESS-CONTROL BOX	
1	1	X	HARNESS-POWER TO CONTROL BOX	
1	1	V	TRANSFORMER 40 VA, 240V/24V	
1	-	W	HARNESS-POWER DISTRIBUTION	
1	1	U	HARNESS-CABLE ASSEMBLY	
1	1	T	2ED HIGH LIMIT 460 F	
2	-	S	ELEMENT, FIREBAR 8.5KW	208 V. 240 V.
-	2	R	ELEMENT, FIREBAR 7KW	208 V. 240 V.
2	2	P	FUSE & HOLDER	HOLDER FUSE
1	1	N	THERMISTOR PROBE	
1	1	K1	NCC CONTROL HARNESS	
1	1	K	NCC TEMPERATURE CONTROL	
1	1	H	RELAY, DPDT 240V COIL	
1	1	G	RELAY, DPDT 24V COIL	
1	1	D1	ROCKER SWITCH ASSEMBLY-START	
2	2	D	ROCKER SWITCH ASSEMBLY	
4	4	C	CONTACTOR 3P 40A 230V COIL	
1	1	B	STRIP-TERMINAL BARRIER	
1	1	A	TERMINAL BLOCK	

DERIVED FROM  
956934-2 REV. C

PAGE 2 OF 2  
SEE AI 2860

AI 2861

208V & 240V (24 kW) Fryers Shown With KleenScreen Filtration System

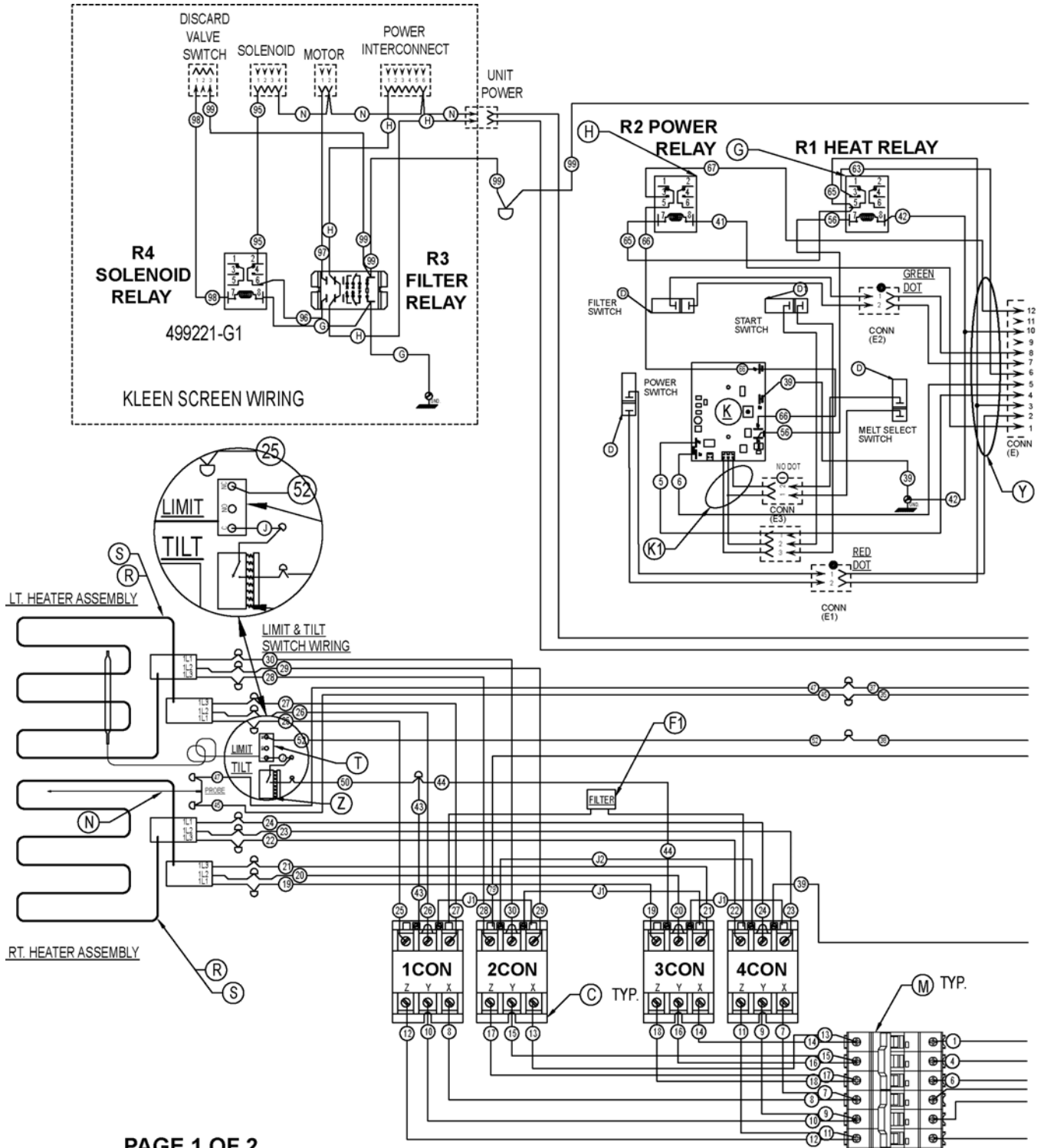

PAGE 1 OF 2  
SEE AI 2892

AI 2891

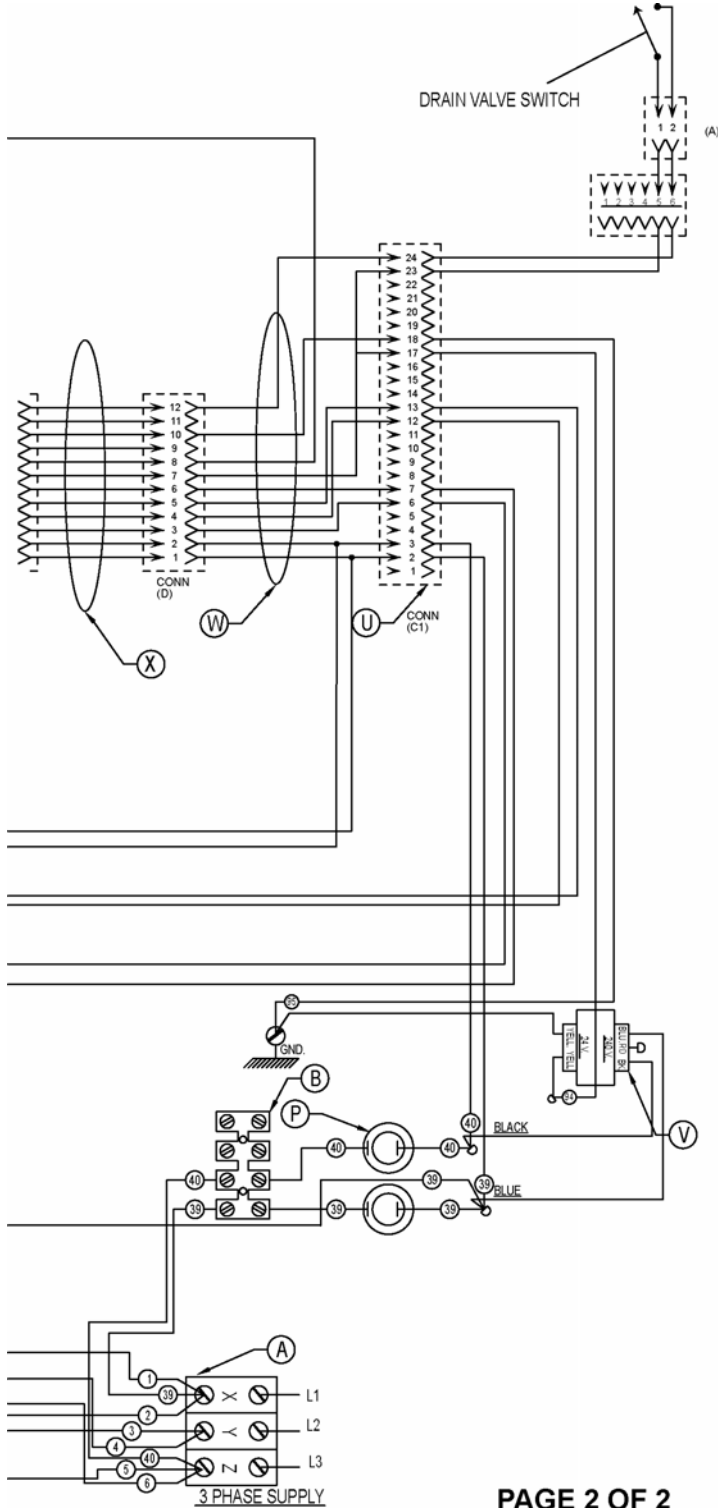

208-240 VOLT PHASE LOAD

TOTAL KW	KW/PHASE		
	X-Y	X-Z	Y-Z
24	8	8	8
AMPS PER LINE 208 VOLT			
	X	Y	Z
24	67	67	67
AMPS PER LINE 240 VOLT			
	X	Y	Z
24	58	58	58

1	-	F1	FILTER ASSEMBLY SINGLE	
1	-	Z	SWITCH, LIMIT	WIRED MAGNET
1	-	Y	HARNESS-CONTROL BOX	
1	-	X	HARNESS-POWER TO CONTROL BOX	
1	-	W	HARNESS-POWER DISTRIBUTION	
1	-	V	TRANSFORMER, 40 VA 240V/24V.	
1	-	U	HARNESS-CABLE ASSEMBLY	
1	-	T	2ED HIGH LIMIT 460 F	
2	-	S	ELEMENT, FIREBAR 12KW	208 V. 240 V.
2	-	P	FUSE & HOLDER	HOLDER FUSE
1	-	N	THERMISTOR PROBE	
2	-	M	CIRCUIT BREAKER 50A 3 POLE	
1	-	L	RELAY, TYCO T92S11 DPDT 24V COIL	
1	-	K1	NCC CONTROL HARNESS	
1	-	K	NCC TEMPERATURE CONTROL	
1	-	H	RELAY, DPDT 240V COIL	
2	-	G	RELAY, DPDT 24V COIL	
1	-	D1	ROCKER SWITCH ASSEMBLY- START	
3	-	D	ROCKER SWITCH ASSEMBLY	
4	-	C	CONTACTOR 3P 40A 230V COIL	
1	-	B	STRIP-TERMINAL BARRIER	
1	-	A	TERMINAL BLOCK	

DERIVED FROM  
956933-2 REV. C

PAGE 2 OF 2  
SEE AI 2891

AI 2892

480V Fryers Shown With KleenScreen Filtration System

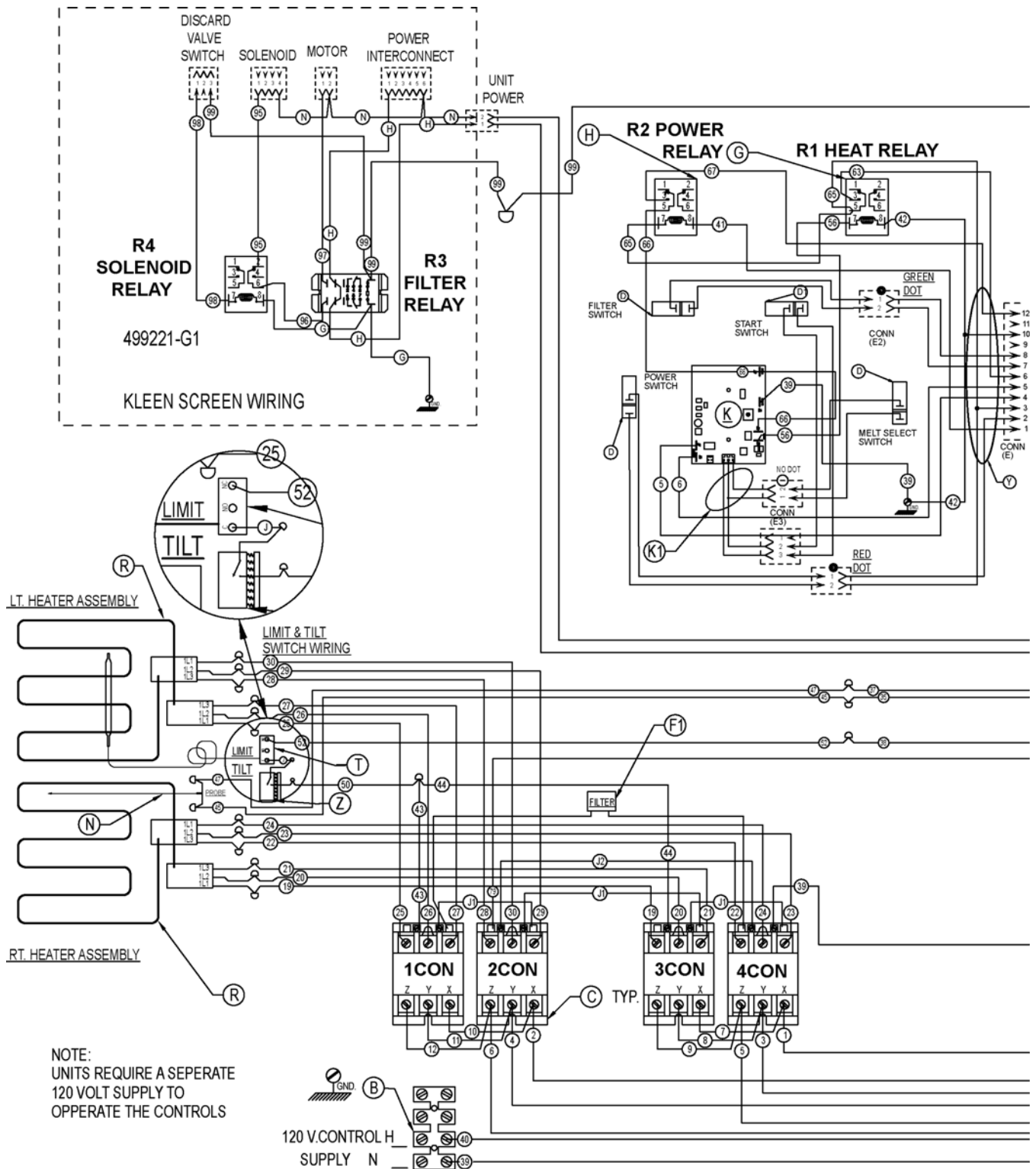

NOTE:  
UNITS REQUIRE A SEPERATE  
120 VOLT SUPPLY TO  
OPERATE THE CONTROLS

PAGE 1 OF 2  
(SEE AI 2863)

AI 2862

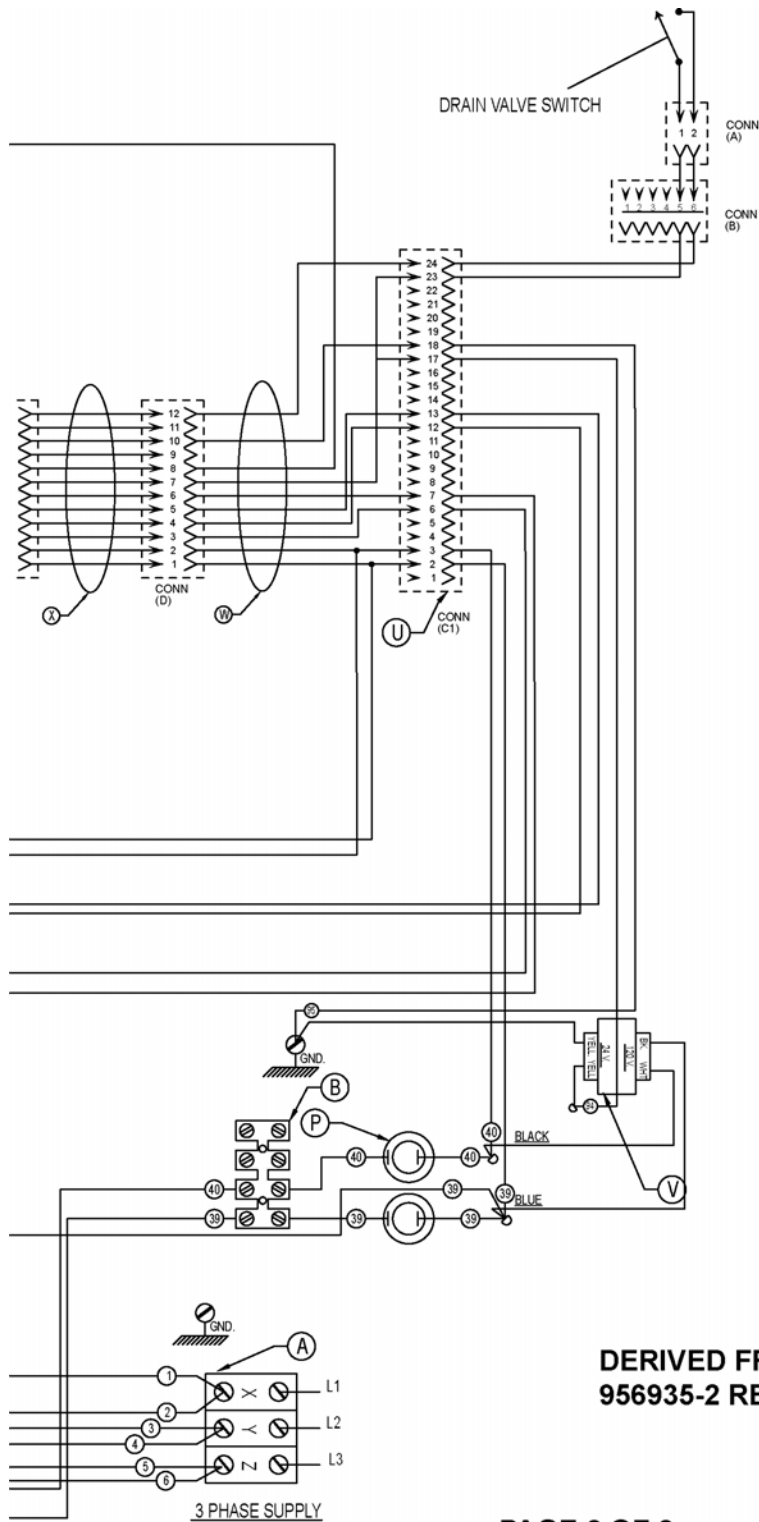

480 VOLT PHASE LOAD

TOTAL KW	KW/PHASE		
	X-Y	X-Z	Y-Z
24	8	8	8
17	5.66	5.66	5.66
14	4.66	4.66	4.66
AMPS PER LINE			
	X	Y	Z
24	29	29	29
17	20	20	20
14	17	17	17

1	1	1	-	F1	FILTER ASSEMBLY SINGLE	
1	1	1	-	Z	SWITCH, LIMIT	WIRE MAGNET
1	1	1	-	Y	HARNESS-CONTROL BOX	
1	1	1	-	X	HARNESS-POWER TO CONTROL BOX	
1	1	1	-	W	HARNESS-POWER DISTRIBUTION	
1	1	1	1	V	TRANSFORMER, 40VA 120/24VAC	
1	1	1	1	T	2ED HIGH LIMIT 460F	
2	-	-	-	R3	ELEMENT, FIREBAR 480V. 12 KW.	
-	2	-	-	R3	ELEMENT, FIREBAR 480V. 10.5 KW.	
-	-	2	-	R2	ELEMENT, FIREBAR 480V. 8.5 KW.	
-	-	-	2	R1	ELEMENT, FIREBAR 480V. 7 KW.	
2	2	2	2	P	FUSE & HOLDER	HOLDER FUSE
1	1	1	1	N	THERMISTOR PROBE	
1	1	1	1	K1	NCC CONTROL HARNESS	
1	1	1	1	K	NCC TEMPERATURE CONTROL	
1	1	1	1	H	RELAY DPDT 120V COIL	
1	1	1	1	G	RELAY, DPDT 24V COIL	
1	1	1	1	D1	ROCKER SWITCH ASSEMBLY - START	
2	2	2	2	D	ROCKER SWITCH ASSEMBLY	
4	4	4	4	C	CONTACTOR 3P 40A 120V COIL	
2	2	2	2	B	STRIP-TERMINAL BARRIER	
1	1	1	1	A	TERMINAL BLOCK	

DERIVED FROM  
956935-2 REV. D

PAGE 2 OF 2  
(SEE AI 2862)

AI 2863

Frymate (Dump Station)

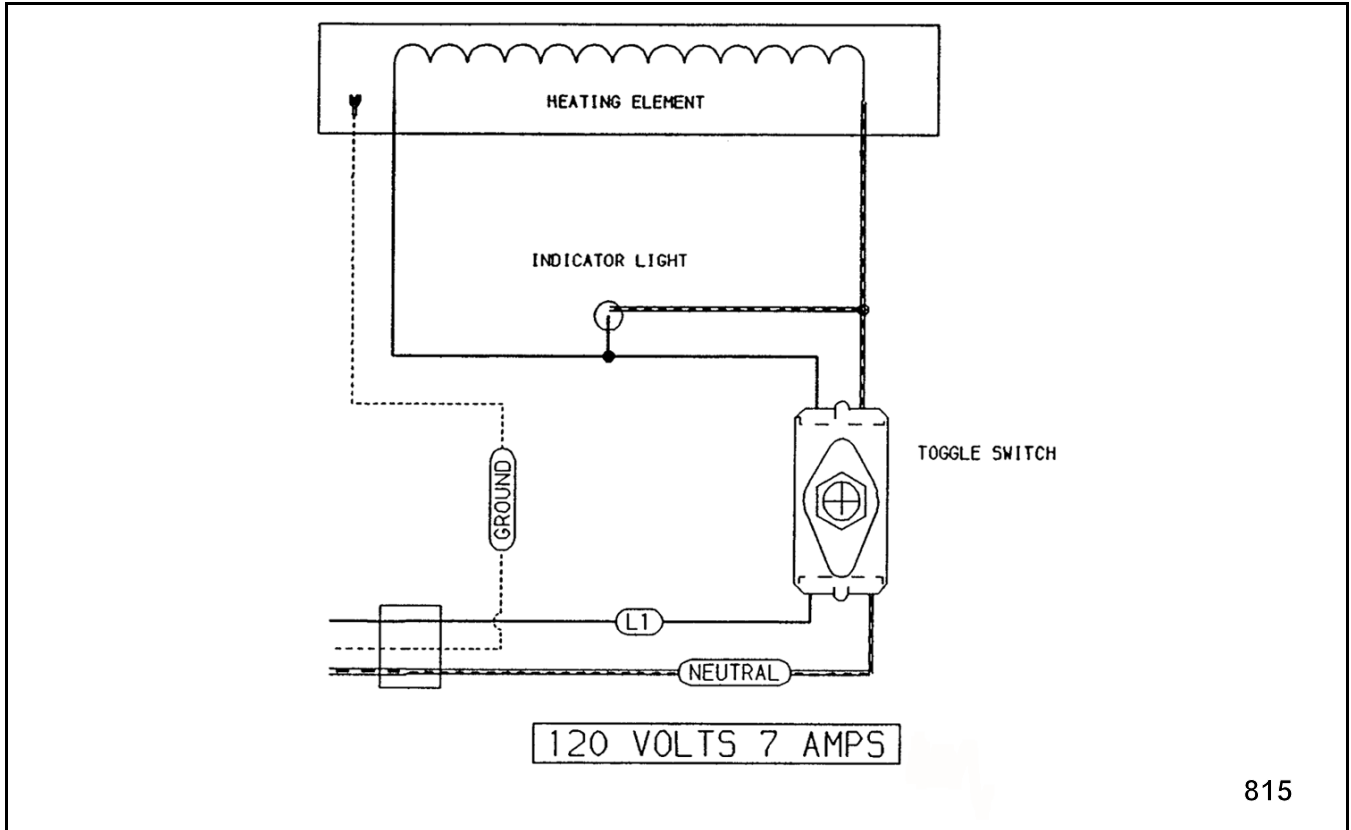

815

# TROUBLESHOOTING

## ALL MODELS

SYMPTOMS	POSSIBLE CAUSES
Fryer does not heat, but voltage IS present between J2 and J9.	<ol style="list-style-type: none"> <li>1. Tilt switch covered with debris or malfunction (heating elements are lowered).</li> <li>2. High limit thermostat open.</li> <li>3. Contactor(s) malfunction.</li> <li>4. Cooking control malfunction (no output from terminal J5).</li> <li>5. R1 heat relay malfunction.</li> <li>6. Interconnecting wiring malfunction.</li> </ol>
Fryer does not heat, voltage NOT present between J2 and J9.	<ol style="list-style-type: none"> <li>1. Check main power to unit.</li> <li>2. Internal circuit breaker OFF (24kW, 208-240V units only).</li> <li>3. Power switch off or malfunction.</li> <li>4. Transformer inoperative.</li> <li>5. R2 power relay malfunction.</li> <li>6. Drain valve switch open or switch malfunction.</li> <li>7. Interconnecting wiring malfunction.</li> </ol>
Excessive time to melt solid shortening (more than 45 minutes).	<ol style="list-style-type: none"> <li>1. Melt cycle timing incorrect.</li> <li>2. Incorrect supply voltage.</li> <li>3. Temperature probe malfunction.</li> <li>4. Cooking control malfunction.</li> </ol>
Excessive or low heat.	<ol style="list-style-type: none"> <li>1. Incorrect supply voltage.</li> <li>2. Temperature probe malfunction.</li> <li>3. Contactor(s) malfunction.</li> <li>4. R1 heat relay malfunction.</li> <li>5. Heating element malfunction (low heat).</li> <li>6. Cooking control malfunction.</li> </ol>
Intermittent problems.	<ol style="list-style-type: none"> <li>1. High ambient temperatures.</li> <li>2. Wiring connections loose.</li> </ol>

## FRYMATE (DUMP STATION) WITH OPTIONAL HEATER

SYMPTOM	POSSIBLE CAUSES
No heat.	<ol style="list-style-type: none"> <li>1. Unplugged.</li> <li>2. Power switch off or inoperative.</li> <li>3. Main circuit breaker off or open.</li> <li>4. Malfunctioning heater assembly.</li> </ol>

## KLEENSCREEN FILTERING SYSTEM

SYMPTOM	POSSIBLE CAUSES
Shortening not filtering, pump motor is energized.	<ol style="list-style-type: none"> <li>1. Filter screen plugged.</li> <li>2. Clog in filter system lines.</li> </ol> <p><b>NOTE:</b> If using solid shortening, when all filtered shortening is returned to the fry tank and filter power switch is off, open the filter drawer approximately one inch. Allow the remaining shortening in the line to drain into the filter tank to prevent possible clogging after the shortening cools and solidifies. Close the filter drawer when complete.</p> <ol style="list-style-type: none"> <li>3. Shortening below 300°F to thick.</li> <li>4. Fill solenoid valve malfunction.</li> <li>5. Interconnecting wiring malfunction.</li> <li>6. Pump is inoperative.</li> </ol>
Shortening not discarding, pump motor energized.	<ol style="list-style-type: none"> <li>1. Filter screen plugged.</li> <li>2. Clog in filter system lines.</li> </ol> <p><b>NOTE:</b> If using solid shortening, when all filtered shortening is returned to the fry tank and filter power switch is off, open the filter drawer approximately one inch. Allow the remaining shortening in the line to drain into the filter tank to prevent possible clogging after the shortening cools and solidifies. Close the filter drawer when complete.</p> <ol style="list-style-type: none"> <li>3. Shortening below 300°F to thick.</li> <li>4. Discard valve switch malfunction (N.O. contacts not closing to energize R3 filter relay coil).</li> <li>5. R3 fill relay malfunction (contacts remain closed).</li> </ol> <p><b>NOTE:</b> The fill solenoid valve should not be energized during discard operation so that shortening will flow thru manual discard valve only.</p> <ol style="list-style-type: none"> <li>6. Discard valve mechanical malfunction.</li> <li>7. Discard hose connection not fully engaged.</li> <li>8. Pump is inoperative.</li> </ol>
Pump motor is not energized to circulate shortening thru filtering system.	<ol style="list-style-type: none"> <li>1. Filter switch on cooking controls not turned on.</li> <li>2. Pump needs reset. (Reset button located on pump)</li> <li>3. R3 filter relay malfunction.</li> <li>4. Interconnecting wiring malfunction.</li> <li>5. Pump motor inoperative.</li> </ol>
Pump motor is not energized to discard shortening.	<ol style="list-style-type: none"> <li>1. Filter switch on cooking controls not turned on.</li> <li>2. Pump needs reset. (Reset button located on pump)</li> <li>3. Discard handle (yellow) not extended.</li> <li>4. R3 filter relay malfunction.</li> <li>5. Interconnecting wiring malfunction.</li> <li>6. Pump motor inoperative.</li> </ol>