

VK and TR GAS FRYERS W/Wo KleenScreen PLUS

VK Series
TR Series

- NOTICE -

This Manual is prepared for the use of trained Vulcan Service Technicians and should not be used by those not properly qualified.

This manual is not intended to be all encompassing. If you have not attended a Vulcan Service School for this product, you should read, in its entirety, the repair procedure you wish to perform to determine if you have the necessary tools, instruments and skills required to perform the procedure. Procedures for which you do not have the necessary tools, instruments and skills should be performed by a trained Vulcan Service Technician.

The reproduction, transfer, sale or other use of this Manual, without the express written consent of Vulcan, is prohibited.

This manual has been provided to you by ITW Food Equipment Group LLC ("ITW FEG") without charge and remains the property of ITW FEG, and by accepting this manual you agree that you will return it to ITW FEG promptly upon its request for such return at any time in the future.

TABLE OF CONTENTS

GENERAL	4
INTRODUCTION	4
MODEL AND ML NUMBERS	4
MODELS, FEATURES AND OPTIONS	5
KLEENSCREEN PLUS FILTRATION SYSTEM: (KSP)	5
SERIAL NUMBER LOCATION	6
CONTROL PANELS	6
INSTALLATION	7
OPERATION	7
CLEANING	7
TOOLS	7
SPECIFICATIONS	7
REMOVAL AND REPLACEMENT OF PARTS	9
COVERS AND PANELS	9
CONTROL PANEL (SOLID STATE AND COMPUTER)	9
BASKET LIFT COVERS	9
ANALOG CONTROL	10
INTERFACE CONTROL - D AND C SERIES	11
POWER SWITCH - D AND C SERIES	11
TEMPERATURE PROBE	11
HIGH LIMIT THERMOSTAT	12
POWER SUPPLY BOX	13
POWER SUPPLY BOX COMPONENTS BEFORE 12/1/12	14
IGNITION MODULE	14
BLOWER CONTROL BOARD	14
TIME DELAY TIMERS	14
BLOWER RELAY	14
FILTER RELAYS (24 VAC AND 120 VAC)	14
120 VOLT TRANSFORMER	15
POWER SUPPLY BOX COMPONENTS AFTER 12/1/12	15
120 VOLT TRANSFORMER	15
CONTROL BOARD	16
FILTER RELAYS	16
BURNER ASSEMBLY	16
GAS VALVE	17
BASKET LIFT TUBE	17
BASKET LIFT MOTOR	18
BASKET LIFT CAM SWITCH	19
BASKET LIFT CAM	19
FILL SOLENOID VALVE (KSP)	19
FILTER HOSE SWITCH (KSP)	20
FILTER PUMP AND MOTOR (KLEENSCREEN FRYERS ONLY)	20
DRAIN VALVE INTERLOCK SWITCH (DVI)	21
FRY TANK	22
SERVICE PROCEDURES AND ADJUSTMENTS	24
ELECTRIC CONNECTIONS	24
HARMONIC TONE	24
TEMPERATURE PROBE FAULT CODES	24
TEMPERATURE PROBE TEST	24
COOKING CONTROL CALIBRATION	25
FLAME SENSE CURRENT CHECK PRIOR TO 12/1/12	25
FLAME SENSE CURRENT CHECK AFTER 12/1/12	26
ELECTRONIC IGNITION CONTROL	26
IGNITION MODULE LOCKOUT	26
ELECTRONIC IGNITION SYSTEM	27

MODULATING GAS VALVE ADJUSTMENTS	27
BASKET LIFT ARM ADJUSTMENT	27
SOLID STATE CONTROL	28
OPERATION	28
SERVICE PROGRAMMING	28
ERROR MESSAGES	28
ENTER SERVICE MODE	28
ALARM MESSAGES	30
COMPUTER CONTROL	31
OPERATION	31
SERVICE PROGRAMMING	31
ENTER SERVICE SETTING MODE	31
ALARM MESSAGES	35
DISPLAY, LED AND KEYPAD TEST - COMPUTER CONTROL	36
BLOWER CONTROL BOARD SETTINGS	36
HIGH/LOW FIRE TIMER SETTING	36
AIR FILTER	37
SPARK GAP SETTING BEFORE 12/1/12	37
SPARK GAP SETTING AFTER 12/1/12	38
ELECTRICAL OPERATION	40
COMPONENT FUNCTION - FRYER CONTROLS	40
COMPONENT FUNCTION - KLEENSCREEN FILTER CONTROLS	41
COMPONENT LOCATION	41
SEQUENCE OF OPERATION - A SERIES - AFTER 12/1/12	42
SEQUENCE OF OPERATION D AND C SERIES	43
SCHEMATIC DIAGRAMS	45
WIRING DIAGRAMS	49
TROUBLESHOOTING	54
TROUBLESHOOTING	54

GENERAL

INTRODUCTION

This service manual covers the specific service information related to the models listed in the chart below. The VK and TR series gas fryers come equipped with solid state analog (A), solid state digital (D) or programmable computer (C) controls. This manual covers single floor model fryers, battery fryers as well as fryers with the KleenScreen PLUS® Filtration System. All pictures and illustrations will be of a 2VK45A unless otherwise noted.

All of the information, illustrations and specifications contained in this manual are based on the latest product information available at the time of printing.

MODEL AND ML NUMBERS

MODEL	ML #	MODEL	ML #	MODEL	ML #
1VK45A	136885	1VK45D	136886	1VK45C	136887
1VK65A	136888	1VK65D	136889	1VK65C	136890
1VK85A	136891	1VK85D	136892	1VK85C	136893
1VK45AF	136684	1VK45DF	136895	1VK45CF	136896
1VK65AF	136897	1VK65DF	136898	1VK65CF	136899
1VK85AF	136900	1VK85DF	136901	1VK85CF	136902
2VK45AF	136903	2VK45DF	136904	2VK45CF	136905
2VK65AF	136906	2VK65DF	136907	2VK65CF	136908
2VK85AF	136909	2VK85DF	136910	2VK85CF	136911
3VK45AF	136912	3VK45DF	136913	3VK45CF	136914
3VK65AF	136915	3VK65DF	136916	3VK65CF	136917
3VK85AF	136918	3VK85DF	136919	3VK85CF	136920
4VK45AF	136921	4VK45DF	136922	4VK45CF	136923
4VK65AF	136935	4VK65DF	136941	4VK65CF	136937
4VK85AF	136938	4VK85DF	136939	4VK85CF	136940
1TR45A	136946	3TR45CF	136959	3TR65CF	136972
1TR45AF	136947	4TR45CF	136960	1TR85A	136973
2TR45AF	136948	1TR65A	136961	1TR85AF	136974
3TR45AF	136949	1TR65AF	136962	2TR85AF	136975
4TR45AF	136950	2TR65AF	136963	3TR85AF	136976
1TR45D	136951	3TR65AF	136964	1TR85D	136977
1TR45DF	136952	1TR65D	136965	1TR85DF	136978
2TR45DF	136953	1TR65DF	136966	2TR85DF	136979
3TR45DF	136954	2TR65DF	136967	3TR85DF	136980
4TR45DF	136955	3TR65DF	136968	1TR85C	136981
1TR45C	136956	1TR65C	136969	1TR85CF	136982

MODEL	ML #	MODEL	ML #	MODEL	ML #
1TR45CF	136957	1TR65CF	136970	2TR85CF	136983
2TR45CF	136958	2TR65CF	136971	3TR85CF	136984
4TR65AF	136985	4TR65DF	136986	4TR65CF	136987
4TR85AF	136988	4TR85DF	136989	4TR85CF	136990

MODELS, FEATURES AND OPTIONS

MODELS, FEATURES AND OPTIONS				
MODEL	FEATURES			OPTIONS
	FRYER WIDTH (INCHES)	SHORTENING CAPACITY PER FRYER (POUNDS)	BTU/HR/SECTION	AUTOMATIC BASKET LIFTS
1VK/TR45A / D / C / AF / DF / CF	15.5"	45 - 50	70,000	SINGLE OR DUAL
1VK/TR65A / D / C / AF / DF / CF	21.0"	65 - 70	80,000	SINGLE OR DUAL
1VK/TR85A / D / C / AF / DF / CF	21.0"	85 - 90	90,000	SINGLE OR DUAL
2VK/TR45AF / DF / CF	31.0"	45 - 50	70,000	SINGLE OR DUAL
3VK/TR45AF / DF / CF	46.5"	45 - 50	70,000	SINGLE OR DUAL
4VK/TR45AF / DF / CF	62.0"	45 - 50	70,000	SINGLE OR DUAL
2VK/TR65AF / DF / CF	42.0"	65 - 70	80,000	SINGLE OR DUAL
3VK/TR65AF / DF / CF	63.0"	65 - 70	80,000	SINGLE OR DUAL
4VK/TR65AF / DF / CF	84.0"	65 - 70	80,000	SINGLE OR DUAL
2VK/TR85AF / DF / CF	42.0"	85 - 90	90,000	SINGLE OR DUAL
3VKTR85AF / DF / CF	63.0"	85 - 90	90,000	SINGLE OR DUAL
4VK/TR85AF / DF / CF	84.0"	85 - 90	90,000	SINGLE OR DUAL

KLEENSCREEN PLUS FILTRATION SYSTEM: (KSP)

The KleenScreen *PLUS*® filtration system is integrated into the VK Series fryer battery. The filter is housed in a pullout drawer assembly at the base of the fryer. The filtering components in the drawer include a stainless steel filter tank, a stainless steel

mesh filter screen with a stainless steel insert, a suction tube and a knurled knob that holds the assembly together. In addition, the KSP comes with a second filtering system; a microfiltration fabric envelope (3), a dedicated stainless steel insert and stainless steel clip that holds the assembly together. With the filter drawer closed, a self-sealing oil return line provides the path to return the filtered shortening back into the fry tank.

This system is designed to provide a through and easy method to filter the shortening. Some of the benefits include:

- Self-contained system eliminating the use of external filter equipment
- Paperless filtering system
- Easy to clean and low maintenance
- Extends the life of the shortening

KSP fryer batteries are standard in single and up to a maximum of a four fryer battery in most cases. Batteries are made up of only fryers, no warming stations.

SERIAL NUMBER LOCATION

Serial number plate is attached to door of fryer.



Fig. 1

This serial number plate supplies more than the serial number. It also contains electric requirements, gas requirements, clearances and agency approvals. This plate is pop riveted to the door and should not be removed. However the door sometimes comes off and can become misplaced. If that happens there is a second serial number location on fryer.



Fig. 2

This serial number plate is attached to bottom rear support panel. This plate is pop riveted to support panel and should not come off.

CONTROL PANELS



24318

ANALOG CONTROL



SOLID STATE CONTROL

24321



COMPUTER CONTROL

21322



USB Port

24319

INSTALLATION

Refer to the [Instruction Manual](#) for detailed installation instructions.

OPERATION

Refer to the [Instruction Manual](#) for specific operating instructions.

CLEANING

Refer to the [Instruction Manual](#) for specific cleaning instructions.

TOOLS

STANDARD

- Standard set of hand tools.

- VOM with A.C. current tester (any quality VOM with a sensitivity of at least 20,000 ohms per volt can be used).

SPECIAL

- Temperature tester (thermocouple type)
- Manometer.
- Combustion Analyzer
- Set of Metric Hex Wrenches (must include a 2 mm wrench)
- Set of jewelers screwdrivers
- Field service grounding kit P/N TL- 84919.
- Burndy pin extraction tool RX2025 GE1; Newark Electronics Catalog Number 16F6666. Used for removing pin terminals on Burndy connectors.
- Thumb Drive (part number 443444) (Customer to supply program for uploading menu items)

SPECIFICATIONS

ELECTRICAL:

- 120VAC supply.
 - Filter motor/pump
 - Basket lift motors
 - Transformer
- 24VAC transformer
 - Fryer controls
 - Basket lift relays
 - Filter relay

MANIFOLD GAS PRESSURES (per fryer section)

- Natural - 0.08" W.C.
- Propane - 0.08" W.C.

BUILDING SUPPLY PRESSURE (MAX)

- Natural Single Fryer - 6" W.C.
Natural Battery Fryer - 8" W.C.
- Propane Single and Battery Fryers - 11" W.C.

NOTE: Natural and propane gases listed above are maximum supply pressures. On fryers built before 12/1/12 a separate gas regulator must be used for pressures exceeding maximum (not supplied with

unit). On fryers built after 12/1/12 an incoming gas pressure regulator is installed on the fryer.

VK INPUT BTU RATING	
VK SERIES	BTU/HR/SECTION
VK45A, VK45AF, VK45D, VK45DF, VK45C, VK45CF	70,000
VK65A, VK65AF, VK65D, VK65DF, VK65C, VK65CF	80,000
VK85A, VK85AF, VK85D, VK85DF, VK85C, VK85CF	90,000

TR INPUT BTU RATING	
TR SERIES	BTU/HR/SECTION
TR45A, TR45AF, TR45D, TR45DF, TR45C, TR45CF	70,000
TR65A, TR65AF, TR65D, TR65DF, TR65C, TR65CF	80,000
TR85A, TR85AF, TR85D, TR85DF, TR85C, VK85CF	90,000

REMOVAL AND REPLACEMENT OF PARTS

COVERS AND PANELS



WARNING Disconnect the electrical power to the machine and follow lockout / tagout procedures.

WARNING Shut off the gas before servicing the unit.

Control Panel (Solid State and Computer)

1. Remove screws at top of control panel and rotate panel downwards.



Fig. 7

2. Disconnect wiring harness then lift panel off.

NOTE: The cooking control, control box, interface board and wiring harness are now accessible.

3. Reverse procedure to install.

Basket Lift Covers

WARNING Shut off the gas before servicing the unit.

WARNING All gas joints disturbed during servicing must be checked for leaks. Check with a soap and water solution (bubbles). Do not use an open flame.

NOTE: This procedure applies to fryers with automatic basket lift option only.

1. Remove basket assembly lift arms from support rods.
2. Remove screws securing upper cover to flue wrap.

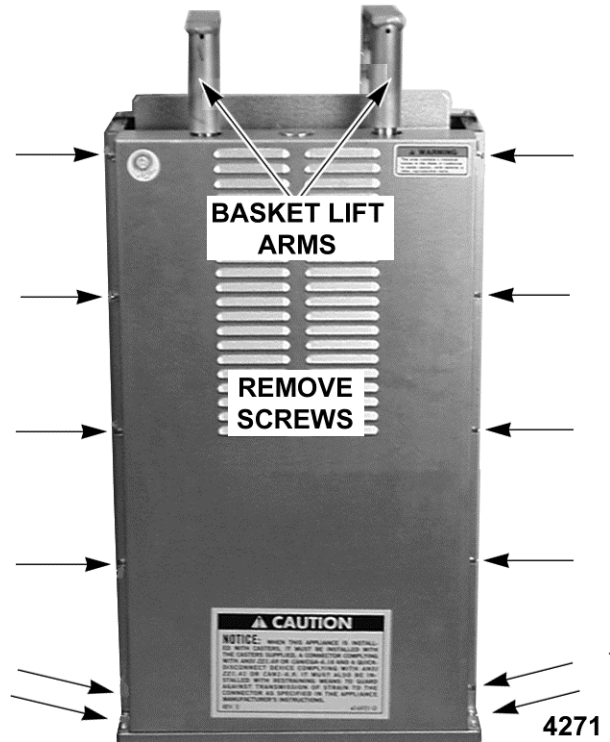

Fig. 8

- A. Lift upper cover over support rods and place cover to the side.

3. Remove screws securing lower cover to motor mounting base.



Fig. 9

4. Reverse procedure to install.

ANALOG CONTROL



⚠ WARNING Disconnect the electrical power to the machine and follow lockout / tagout procedures.

⚠ WARNING Shut off the gas before servicing the unit.

1. Open the door.
2. Unplug wiring harnesses from bottom of control box.
3. Remove control box from frame of fryer.
4. Loosen set screw in control knob and remove from shaft.



24318

Fig. 10

5. Remove control box cover.

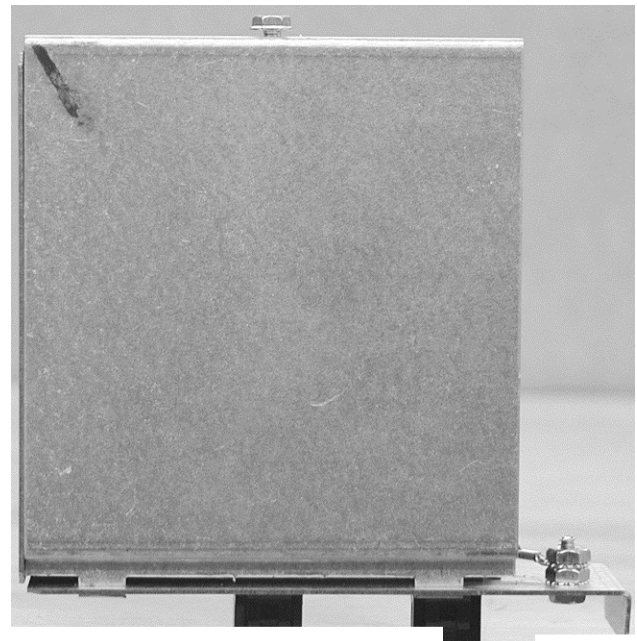

ANALOG CONTROL BOX COVER 24425

Fig. 11

6. Disconnect lead wires as necessary to remove control.

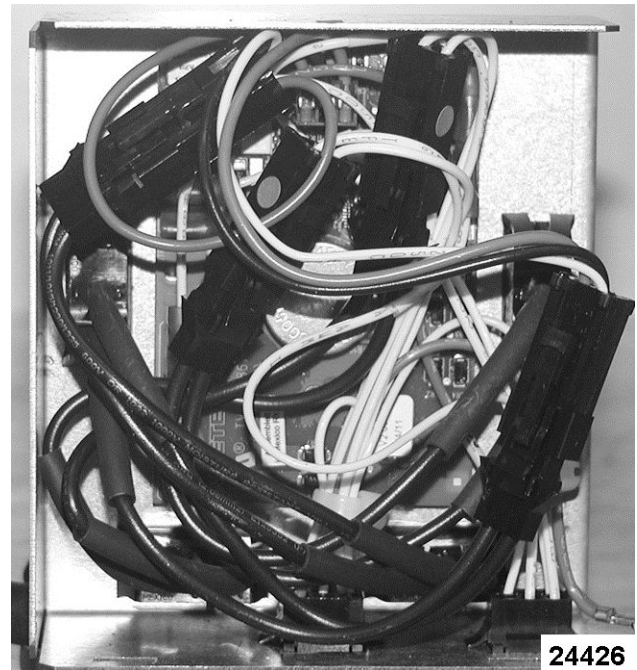

24426

Fig. 12

7. Remove screws from front of control panel and remove control.

INTERFACE CONTROL - D and C SERIES



WARNING Disconnect the electrical power to the machine and follow lockout / tagout procedures.

WARNING Shut off the gas before servicing the unit.

1. Remove CONTROL PANEL.
2. Note lead wire locations and remove wiring.
3. Remove screws securing control to fryer and remove.

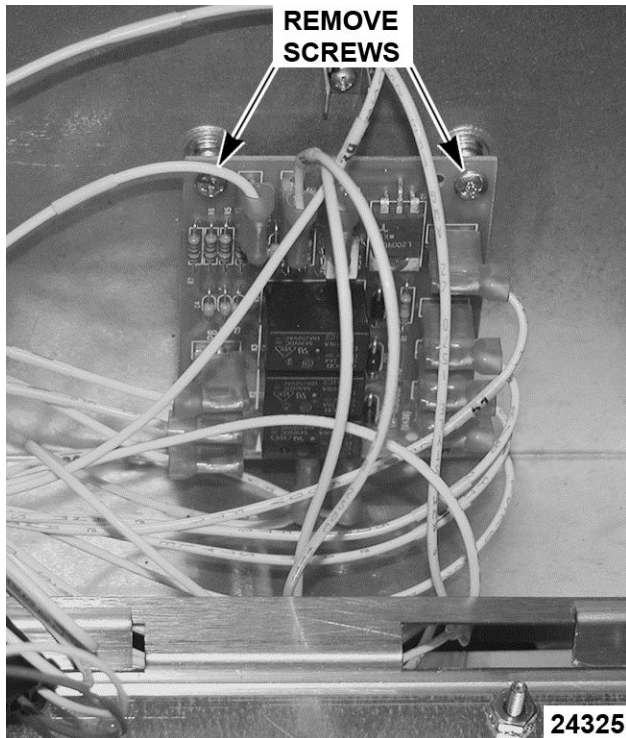

Fig. 13

4. Reverse procedure to install and check for proper operation.

POWER SWITCH - D and C SERIES



WARNING Disconnect the electrical power to the machine and follow lockout / tagout procedures.

NOTE: This procedure is for solid state and computer controls. Power switch for analog controls is part of the analog control box.

1. Open fryer door to access power switch.

UNPLUG CONNECTOR

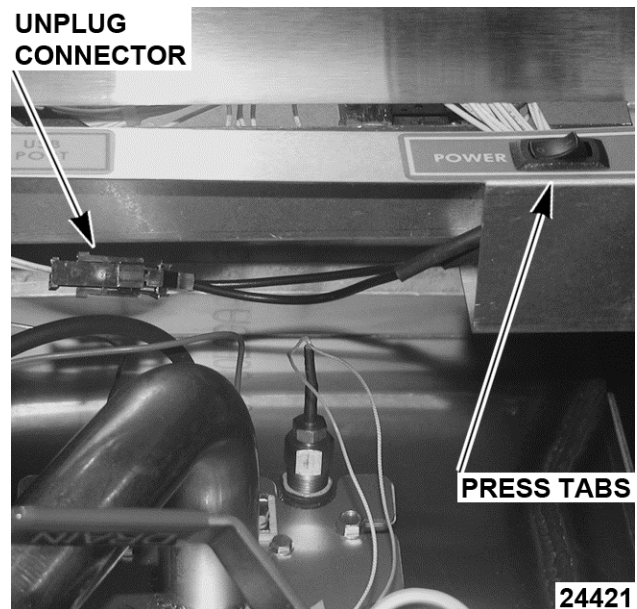

Fig. 14

2. Unplug power switch connector.
3. Reach behind power switch and press tabs on both sides of power switch to remove switch.

NOTE: Power switch is removed from front of the panel.

4. Reverse procedure to install new power switch.
5. Check operation of machine.

TEMPERATURE PROBE



WARNING Disconnect the electrical power to the machine and follow lockout / tagout procedures.

WARNING Shut off the gas before servicing the unit.

1. Drain shortening from fryer tank.

- Unplug temperature probe lead wire connector.



Fig. 15

NOTE: This picture shows the probes with the burner removed.

- Loosen compression nut and remove probe from fryer.

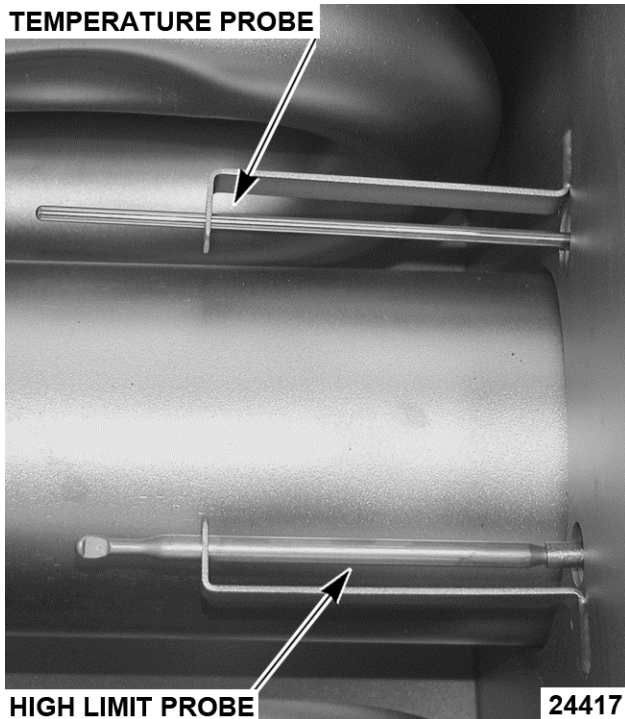

Fig. 16

- Install new probe making sure that probe is installed into bracket shown.

HIGH LIMIT THERMOSTAT



WARNING Disconnect the electrical power to the machine and follow lockout / tagout procedures.

WARNING Shut off the gas before servicing the unit.

NOTICE Do not sharply bend or kink the high limit capillary tube or damage may occur.

- Drain shortening from fryer tank.
- Disconnect lead wires from high limit thermostat.
- Remove screws securing high limit to mounting bracket.

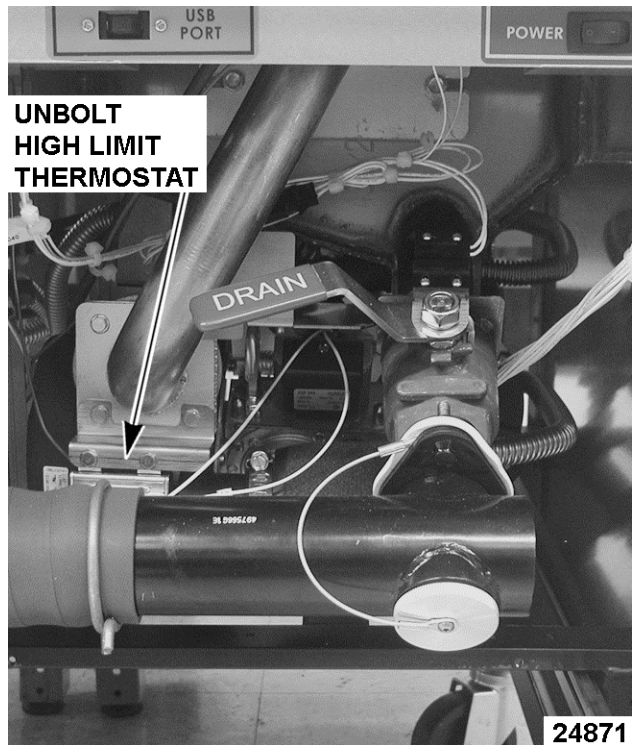

Fig. 17

- Remove the capillary tube retaining and packing nuts.



Fig. 18

NOTE: This picture shows the probes with the burner removed.

- Slide high limit probe out of fry tank.

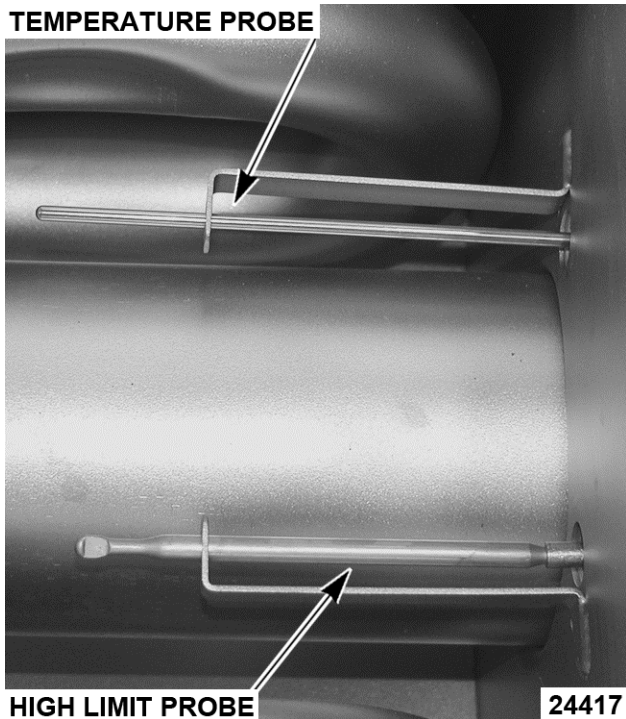

Fig. 19

- Reverse procedure to install and check for proper operation.

POWER SUPPLY BOX



WARNING Disconnect the electrical power to the machine and follow lockout / tagout procedures.

WARNING Shut off the gas before servicing the unit.

WARNING All gas joints disturbed during servicing must be checked for leaks. Check with a soap and water solution (bubbles). Do not use an open flame.

NOTE: The power supply box must be removed to access the following components: ignition module, all 24 volt relays, blower control board, both time delay timers, 120 volt transformer.

- Access rear of fryer and remove screw holding power supply box to support bracket. The box will lower to clear bracket.

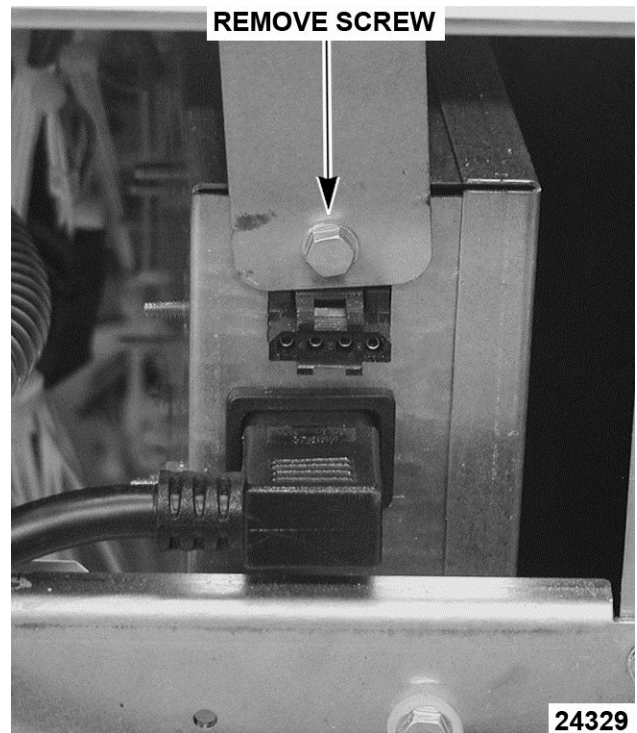

Fig. 20

- Access front of fryer to slide power supply box toward rear of fryer to disconnect from front support bracket.

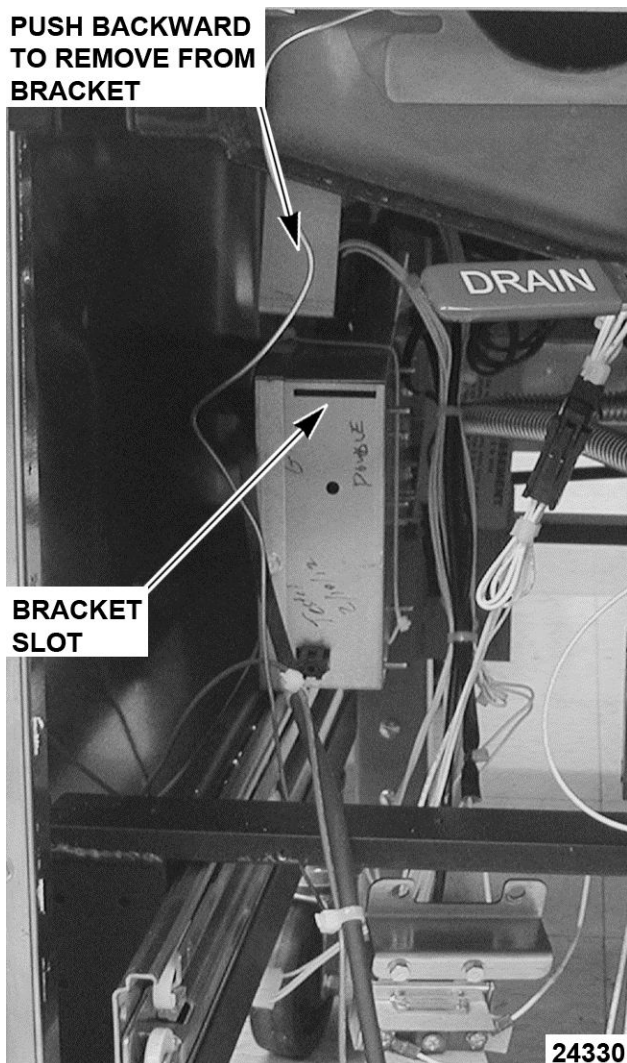

Fig. 21

3. Unplug all connectors from power supply box and remove box from under fryer.
4. Remove cover to access power supply box components.

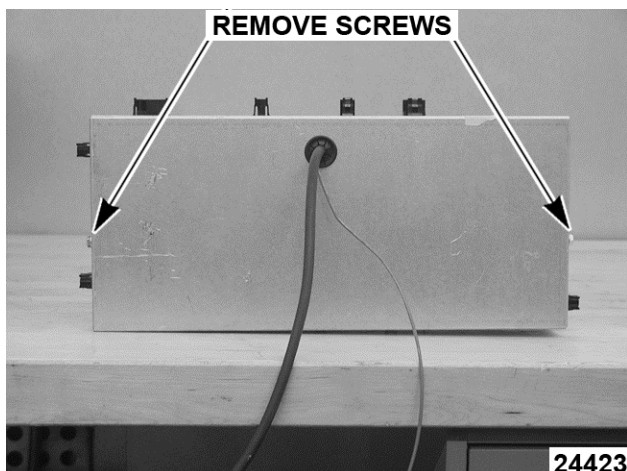

Fig. 22

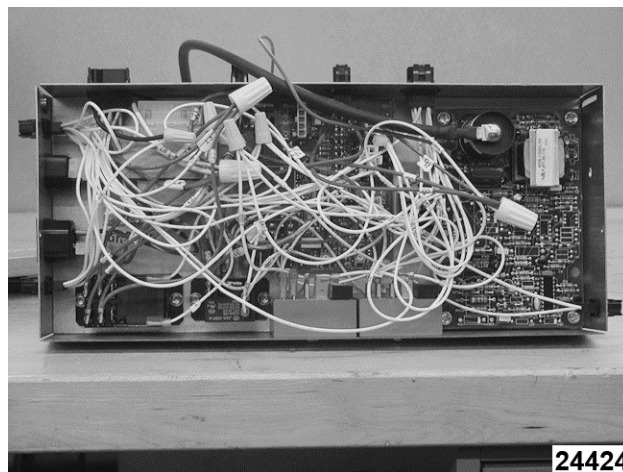

Fig. 23

5. Reverse procedure to install.

POWER SUPPLY BOX COMPONENTS BEFORE 12/1/12

NOTE: The ignition module, blower control board and the time delay timers will not be available to the field any longer. If any one of these items fail, replace power supply box. However, the filter relays and the transformer are still available and can be replaced in the field.

Ignition Module

Replace with updated Power Supply Box Assembly.

Blower Control Board

Replace with updated Power Supply Box Assembly.

Time Delay Timers

Replace with updated Power Supply Box Assembly.

Blower Relay

Replace with updated Power Supply Box Assembly.

Filter Relays (24 VAC and 120 VAC)

1. Remove POWER SUPPLY BOX.
2. Note location of all wiring to the relay and remove wiring.
3. Remove screw and remove relay from box.

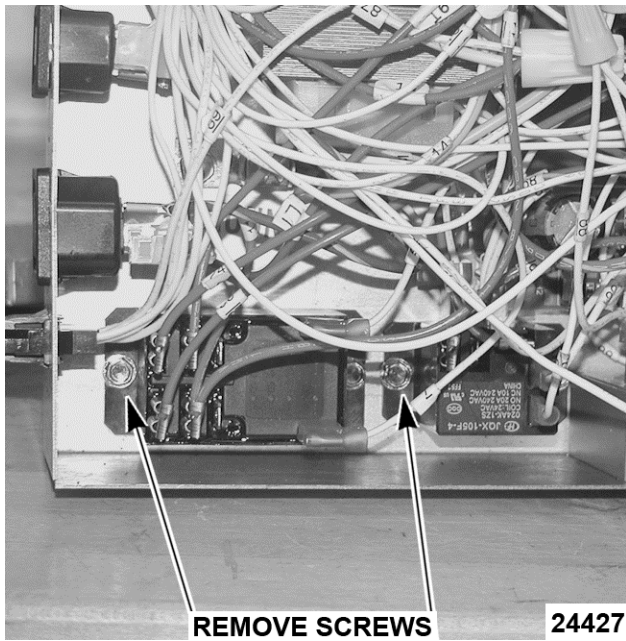

Fig. 24

4. Reverse procedure to install new relay.
5. Reinstall power supply box and check operation.

120 Volt Transformer

1. Remove POWER SUPPLY BOX.
2. Note location of wiring on 120 volt transformer and remove wiring.
3. Remove screws and remove transformer from the box.

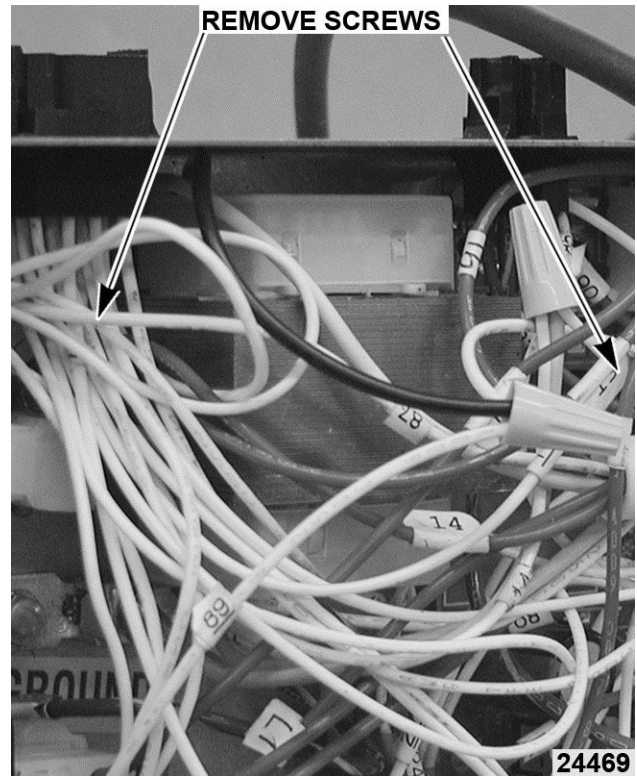

Fig. 25

4. Reverse procedure to install new transformer.
5. Reinstall power supply box and check operation.

POWER SUPPLY BOX COMPONENTS AFTER 12/1/12

NOTE: Power supply boxes built after 12/1/12 have different components in them. The 24 volt electronic ignition relay, blower control board, ignition module and both time delay relays are replaced by a single control board.

NOTE: The new ignition module will not have a separate flame sense rod and wire. Ignition module will rectify flame through high voltage wire.

120 Volt Transformer

1. Remove POWER SUPPLY BOX.
2. Note location of all wiring and remove wiring from transformer.
3. Remove four screws and remove transformer from box.

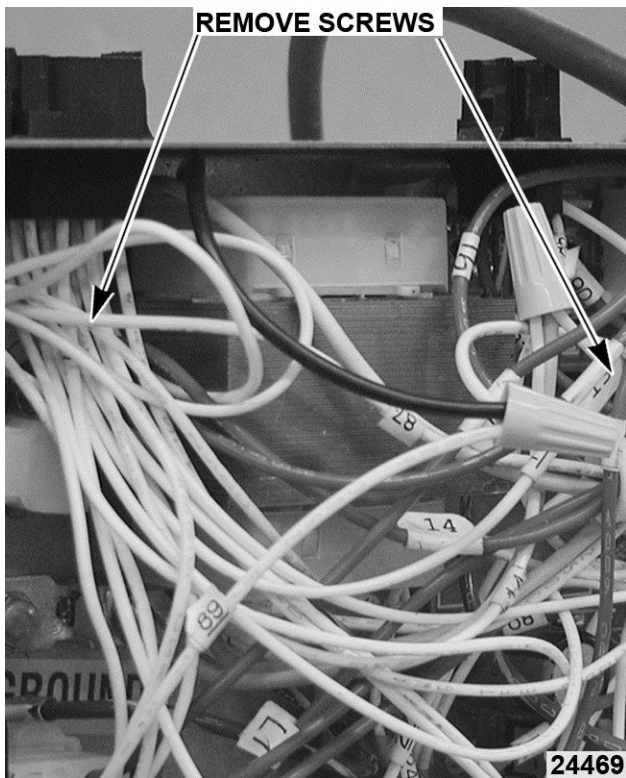

Fig. 26

4. Reverse the procedure to install new transformer.
5. Reinstall power supply box and check operation.

Control Board

1. Remove POWER SUPPLY BOX.
2. Note location of wiring to relay control board and remove wiring.

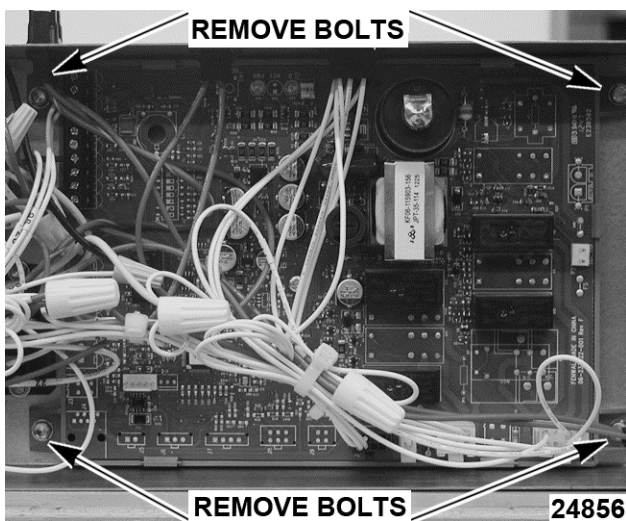

Fig. 27

3. Remove screws and remove from box.
4. Reverse the procedure to install new relay control board.

5. Reinstall power supply box and check operation.

Filter Relays

1. Remove POWER SUPPLY BOX.
2. Note location of wiring to the relays and remove wiring.

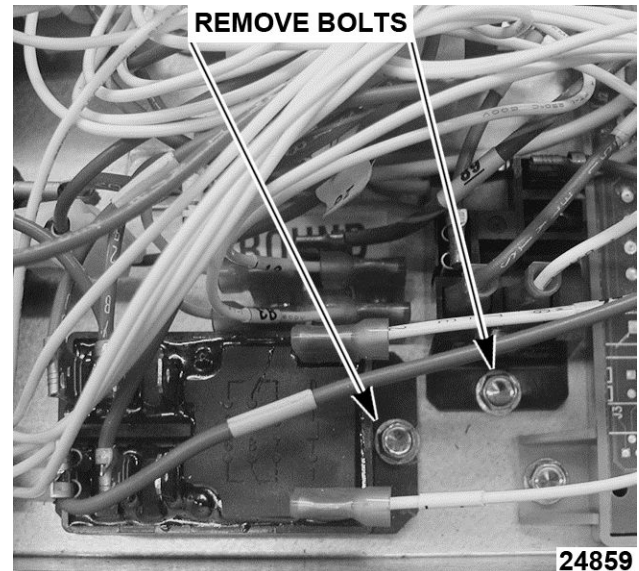

Fig. 28

3. Remove screws and remove from box.
4. Reverse the procedure to install new relays.
5. Reinstall power supply box and check operation.

BURNER ASSEMBLY



WARNING Disconnect the electrical power to the machine and follow lockout / tagout procedures.

WARNING Shut off the gas before servicing the unit.

WARNING All gas joints disturbed during servicing must be checked for leaks. Check with a soap and water solution (bubbles). Do not use an open flame.

1. Remove gas line from gas valve.
2. Remove electric plug connector from gas valve.
3. Unbolt high limit thermostat clamp from transfer tube.

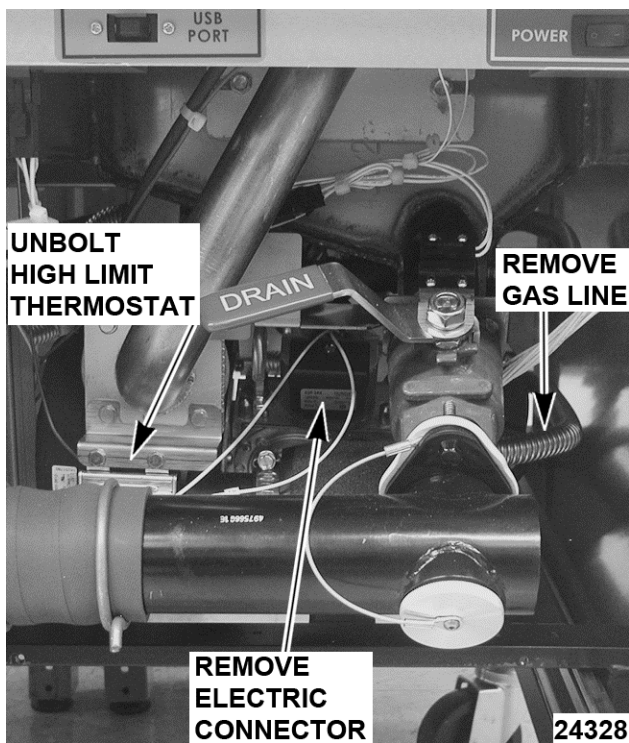

Fig. 29

4. Remove bolts and remove burner from fryer.

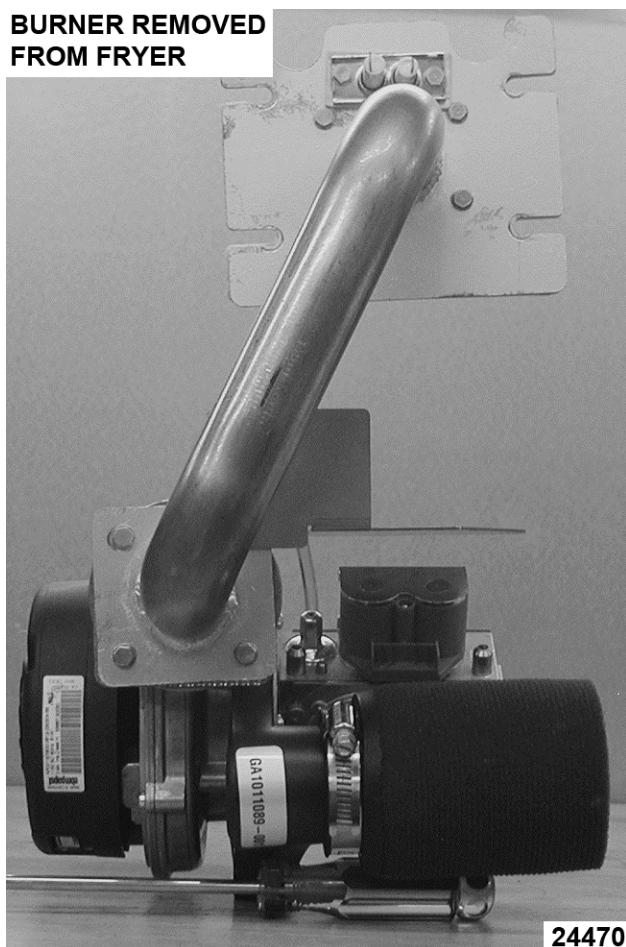

Fig. 30

5. Reverse procedure to reinstall burner.

GAS VALVE



⚠ WARNING Disconnect the electrical power to the machine and follow lockout / tagout procedures.

⚠ WARNING Shut off the gas before servicing the unit.

⚠ WARNING All gas joints disturbed during servicing must be checked for leaks. Check with a soap and water solution (bubbles). Do not use an open flame.

The gas valve is considered part of the burner assembly. If the gas valve fails and needs to be replaced, you must order a complete blower/gas valve assembly (burner). The reason for this is every blower/gas valve assembly (burner) is set up at the factory to operate at the most efficient level possible. This set up procedure cannot be duplicated in the field. If you feel that the gas valve is not set up correctly or not operating correctly, call product service and they will help solve the problem.

BASKET LIFT TUBE



⚠ WARNING Disconnect the electrical power to the machine and follow lockout / tagout procedures.

1. Remove BASKET LIFT COVERS.
2. Remove nut securing lift bar to lift tube.
3. Remove screws securing lift tube bracket to fryer then remove bracket and lift tube.

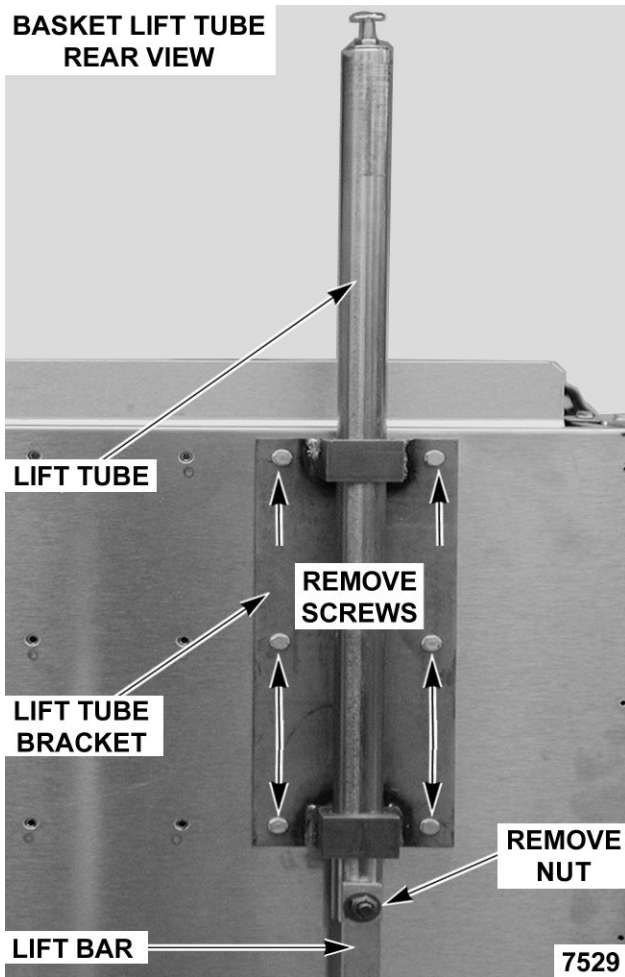

Fig. 31

4. Reverse procedure to install.

BASKET LIFT MOTOR



WARNING Disconnect the electrical power to the machine and follow lockout / tagout procedures.

1. Remove BASKET LIFT TUBE.
2. Disconnect lead wires from cam switch and basket lift motor.
3. Loosen set screws securing crank arm assembly to basket lift motor shaft.

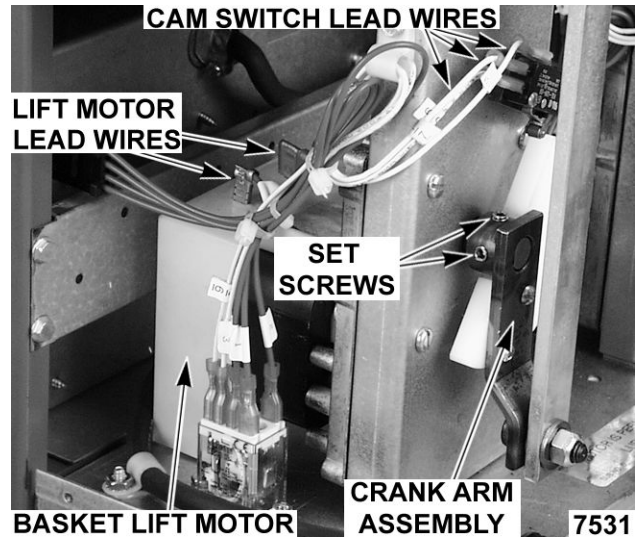

Fig. 32

4. Remove screws securing basket lift motor to cam bracket, then remove motor from bracket.

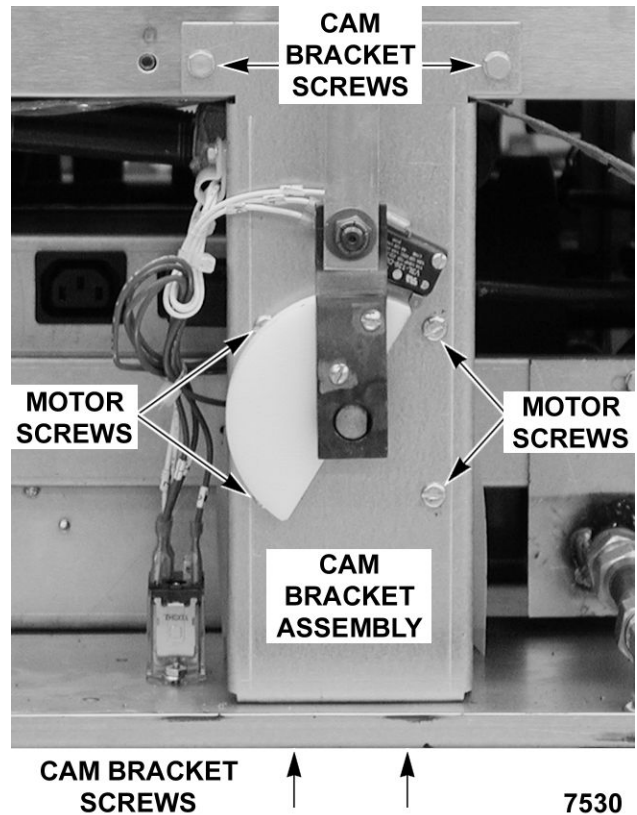

Fig. 33

5. Reverse procedure to install and check for proper operation.

NOTE: After reinstalling motor keep all wire leads clear from moving parts.

BASKET LIFT CAM SWITCH



WARNING Disconnect the electrical power to the machine and follow lockout / tagout procedures.

1. Remove BASKET LIFT TUBE.
2. Disconnect lead wires from cam switch.
3. Remove screws securing cam switch to cam bracket.

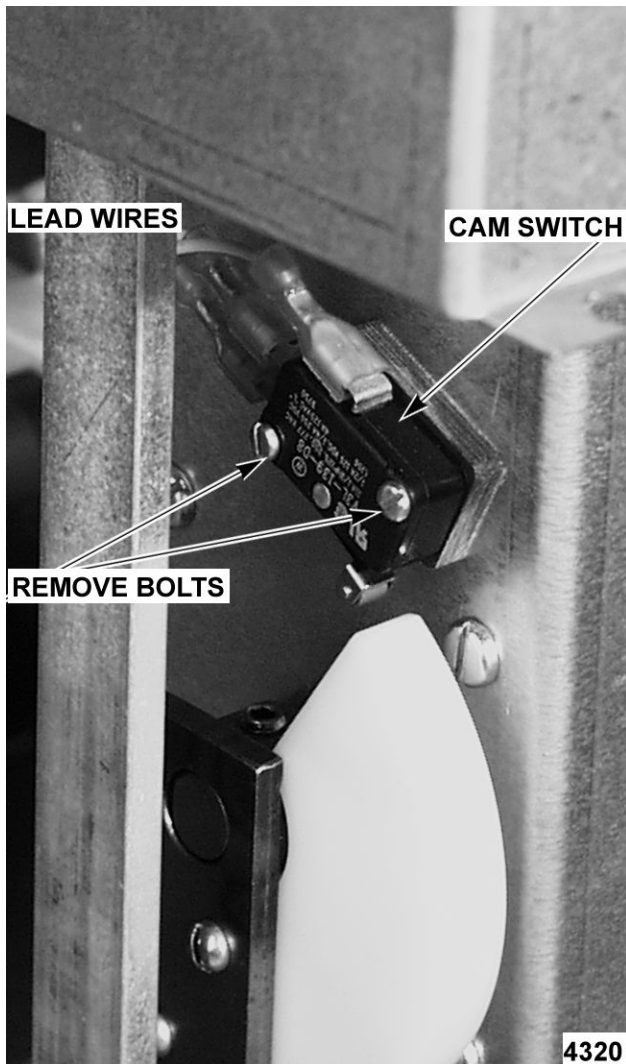

Fig. 34

4. Reverse procedure to install.

BASKET LIFT CAM



WARNING Disconnect the electrical power to the machine and follow lockout / tagout procedures.

1. Remove BASKET LIFT COVERS.
2. Remove nut securing lift bar to cam assembly.
3. Loosen cam set screw.
4. Remove screws securing cam to the crank arm assembly.

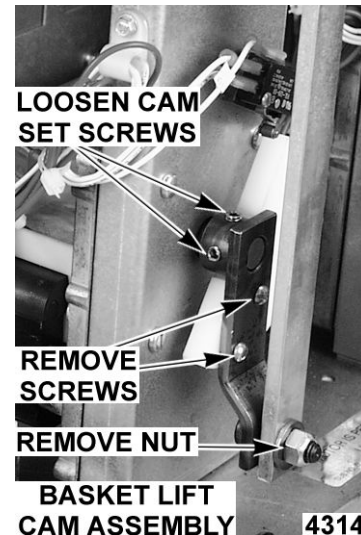

Fig. 35

5. Reverse procedure to install.

FILL SOLENOID VALVE (KSP)



WARNING Disconnect the electrical power to the machine and follow lockout / tagout procedures.

WARNING Shut off the gas before servicing the unit.

1. Remove filter tank from fryer.
2. Access fill solenoid valve.
3. Loosen union at rear of valve,
4. Remove bolts securing valve and remove valve from the fryer.

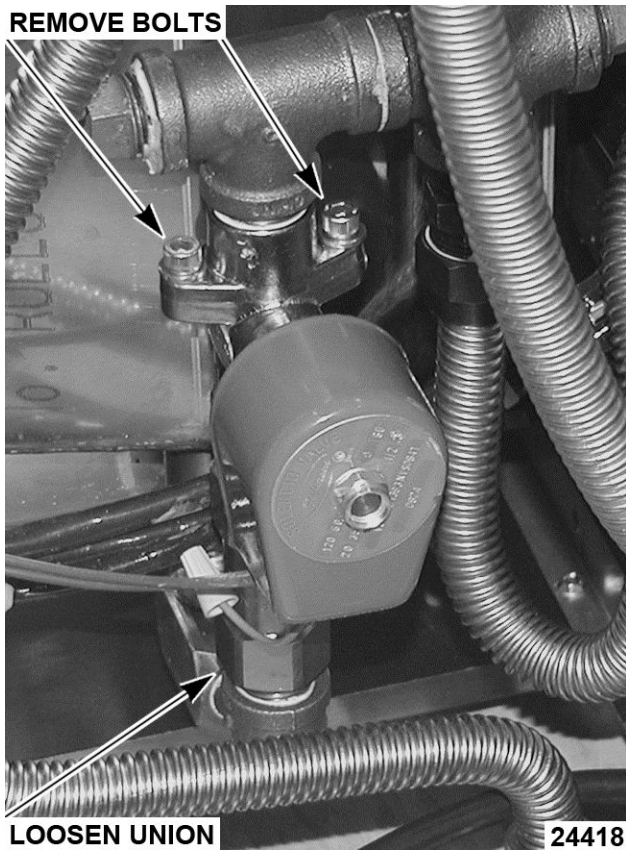

Fig. 36

- Reverse procedure to reinstall valve.

FILTER HOSE SWITCH (KSP)



WARNING Disconnect the electrical power to the machine and follow lockout / tagout procedures.

- Open fryer door to access filter hose switch.
- Unplug lead wire connections.

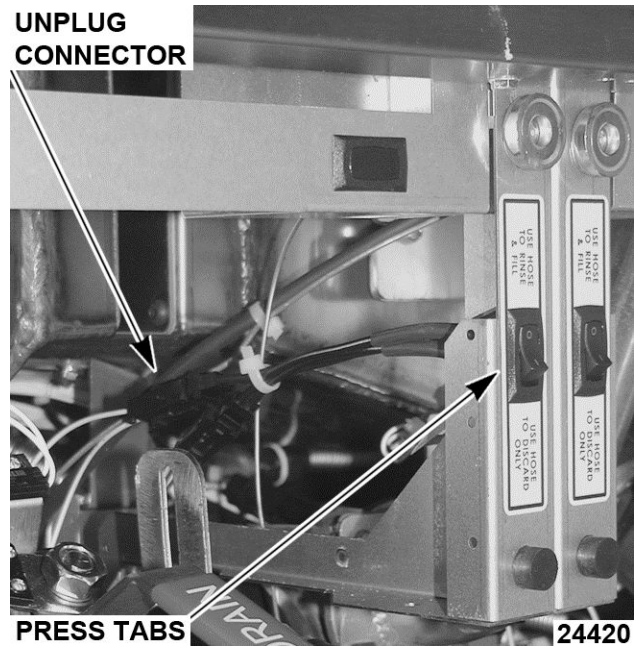

Fig. 37

- Press tabs on rear of switch and push out front of fry cabinet.
- Reverse procedure to install new switch.

FILTER PUMP AND MOTOR (KLEENSCREEN FRYERS ONLY)



WARNING Disconnect the electrical power to the machine and follow lockout / tagout procedures.

- Access rear of fryer.
- Remove four bolts holding serial plate bracket, and carefully lower bracket.
- Disconnect both hoses from filter pump.

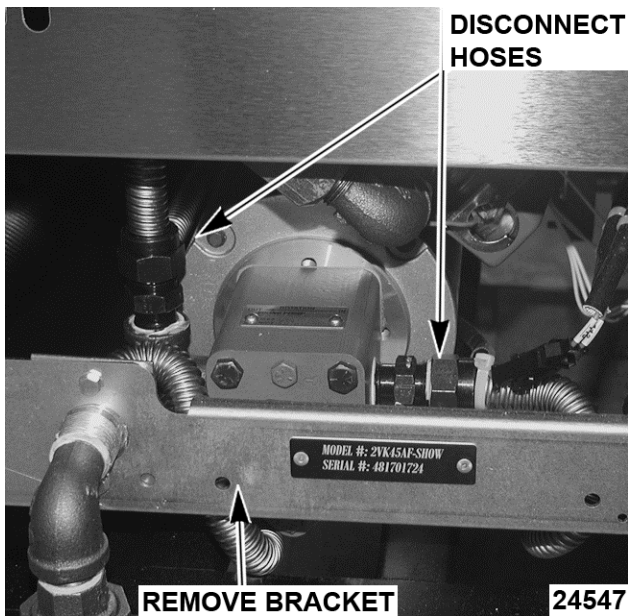

Fig. 38

4. Disconnect electric connections to filter pump motor.
5. Unbolt filter pump motor from fryer frame.
6. Carefully remove filter pump assembly through rear of fryer.
7. Reverse procedure to reinstall filter pump assembly.

DRAIN VALVE INTERLOCK SWITCH (DVI)



⚠ WARNING Disconnect the electrical power to the machine and follow lockout / tagout procedures.

⚠ WARNING Shut off the gas before servicing the unit.

1. Open fryer section door.
2. Locate drain valve switch
3. Remove nut holding drain valve handle and remove handle.

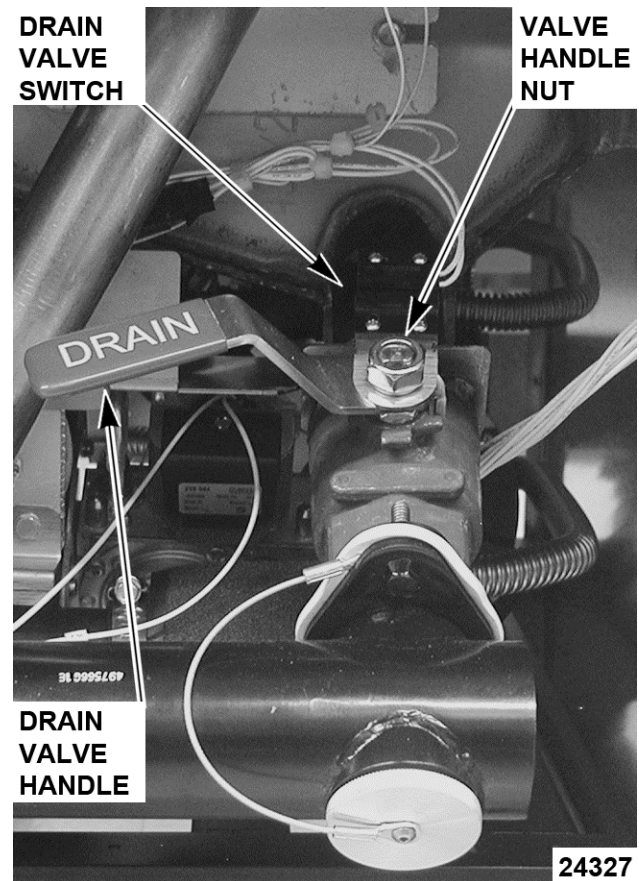

Fig. 39

NOTE: Make sure drain handle is in closed position. If fry tank is full of shortening, carefully remove drain handle. Make sure you do not turn handle to open position. Doing so will allow shortening to drain on floor or you.

4. Remove drain valve interlock switch bracket from valve.
5. Remove screws holding the drain valve interlock switch on bracket and take switch from bracket.

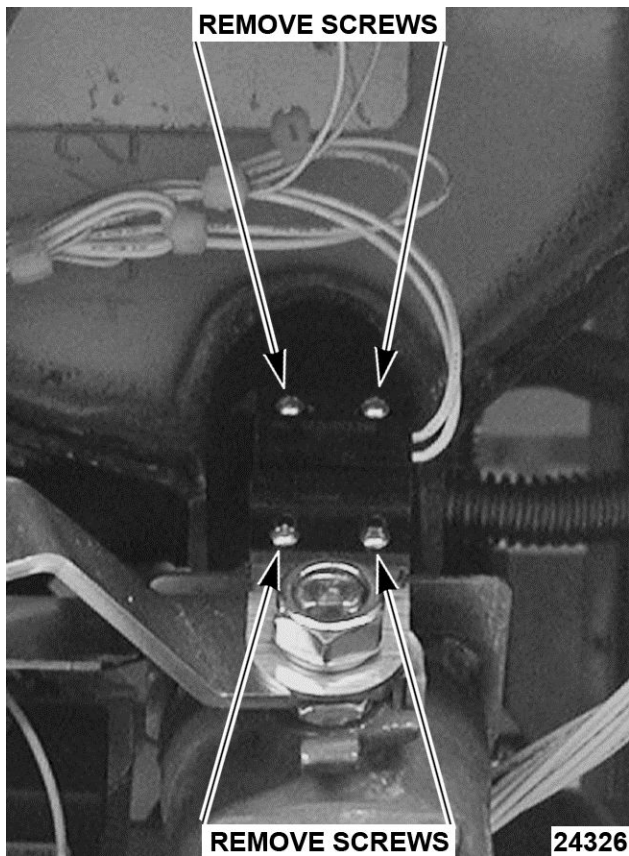

Fig. 40

6. Unplug drain valve interlock switch from wiring harness and remove switch from fryer.
7. Reverse procedure to install and check for proper operation.

FRY TANK



WARNING Disconnect the electrical power to the machine and follow lockout / tagout procedures.

WARNING Shut off the gas before servicing the unit.

WARNING All gas joints disturbed during servicing must be checked for leaks. Check with a soap and water solution (bubbles). Do not use an open flame.

1. Remove BURNER ASSEMBLY.
2. Remove both HIGH LIMIT THERMOSTAT and TEMPERATURE [ROBE].
3. Remove DRAIN VALVE INTERLOCK SWITCH.
4. Remove drain assembly from drain valve.

- A. Remove hose clamp from rubber boot.
- B. Remove drain piping from drain valve.

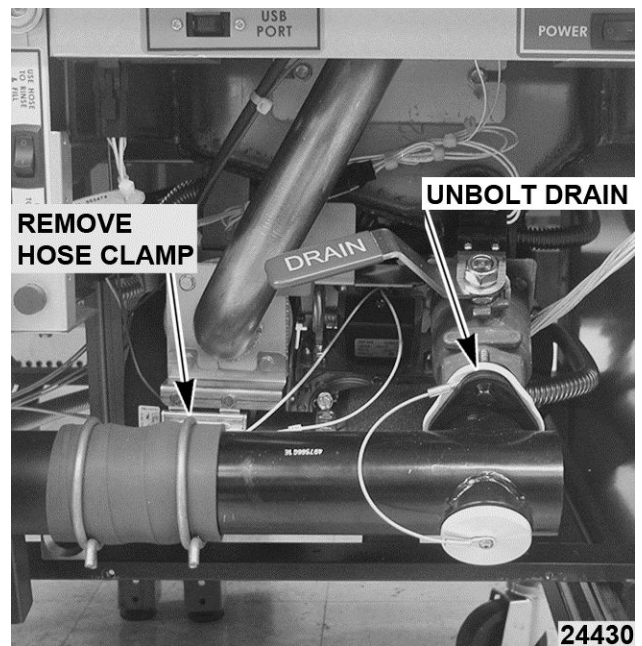

Fig. 41

5. Remove drain valve from fry tank.

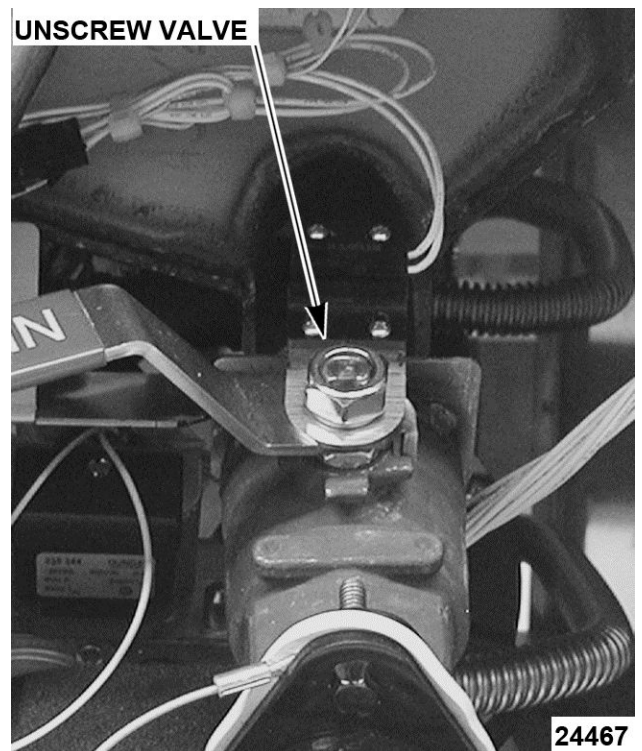

Fig. 42

6. Loosen and disconnect the oil return line, if equipped with filter system.

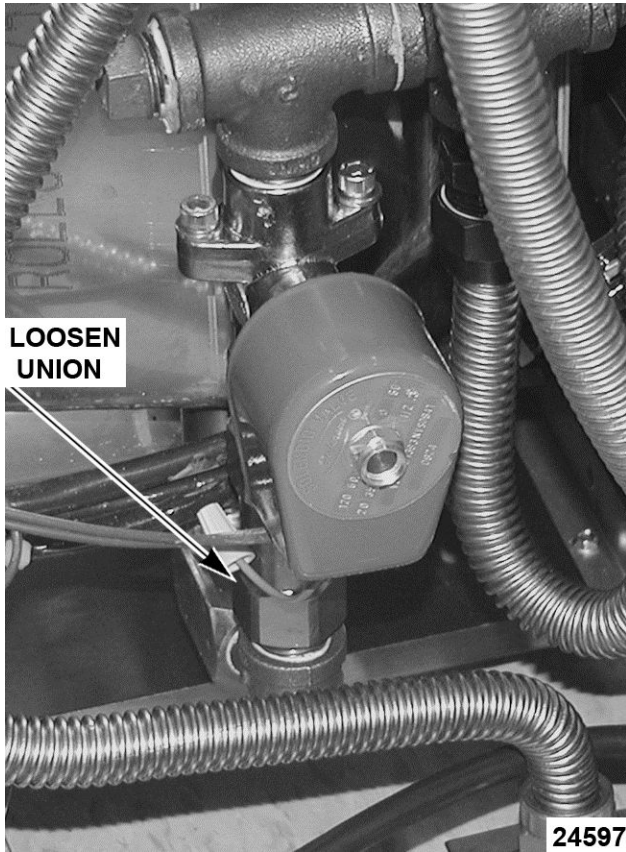

Fig. 43

7. Remove fry tank bolt down bracket.

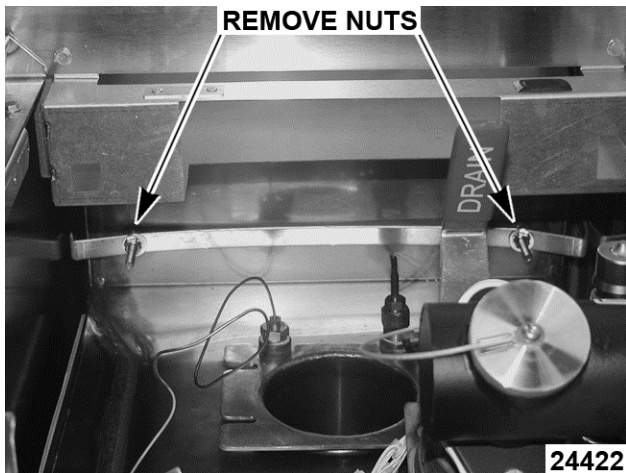

Fig. 44

8. Remove fry tank cover plate.

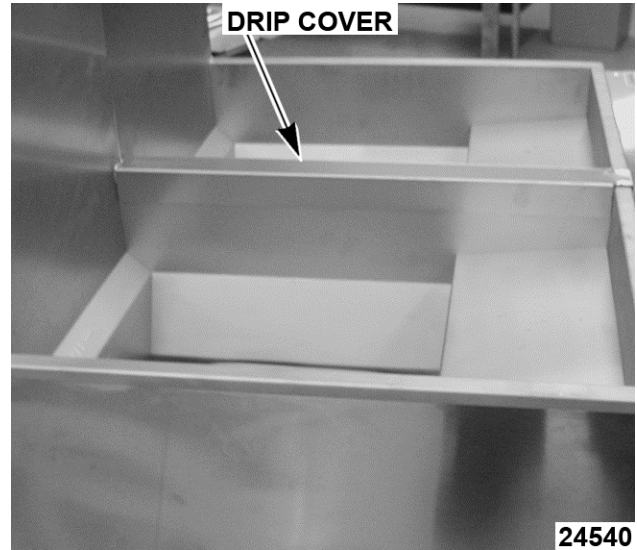

Fig. 45

- A. Cover plate is glued to tank and will have to be pried off.
 - B. Order a replacement plate prior to replacing fry tank.
9. If basket lifts are installed, they will have to be removed from rear of tank.
 10. Remove tank from fryer.



Fig. 46

11. Reverse order of this procedure to install new fry tank.

SERVICE PROCEDURES AND ADJUSTMENTS



WARNING Certain procedures in this section require electrical test or measurements while power is applied to the machine. Exercise extreme caution at all times and follow Arc Flash procedures. If test points are not easily accessible, disconnect power and follow Lockout/Tagout procedures, attach test equipment and reapply power to test.

ELECTRIC CONNECTIONS

The VK series fryers are supplied with a 120Volt cord and three prong plug. If local electrical codes require that these fryers be plugged into a Ground Fault Interrupter or GFI. You must use GFI part number 913053. Other GFI outlets may not have the correct tolerance for the spark to ground ignition system employed with the VK series fryers.

HARMONIC TONE

Harmonic Tone (hum) at First Start

At first start, fryer will begin heating in low fire. There will be a harmonic tone that is NORMAL to hear. As fryer continues to heat, harmonic tone will dissipate and become less noticeable. When fryer reaches 135°F (end of melt cycle), fryer will heat on high fire and blower speed will increase.

TEMPERATURE PROBE FAULT CODES

The temperature probe is used for both the solid state control and the computer control. The probe is an RTD (resistance temperature detector) of the thermistor type. As temperature increases the resistance value decreases.

Probe Fault

If a temperature probe fault or high temperature condition occurs, a fault message will be displayed and the electronic alarm will sound continuously. The heat demand and basket lift outputs are de-activated. If a cooking cycle is in process (timer active), it will be cancelled and the key pad disabled.

This will continue until the fault clears, power is cycled or problem resolved.

CONTROL TYPE	FAULT
SOLID STATE	An open will display Prob and a short or high temperature condition will display HI.

CONTROL TYPE	FAULT
COMPUTER	An open will display PROBE OPEN and a short or high temperature condition will display PROBE SHORT.

TEMPERATURE PROBE TEST

To Check:

1. Turn power switch off.
2. Disconnect the temperature probe plug.

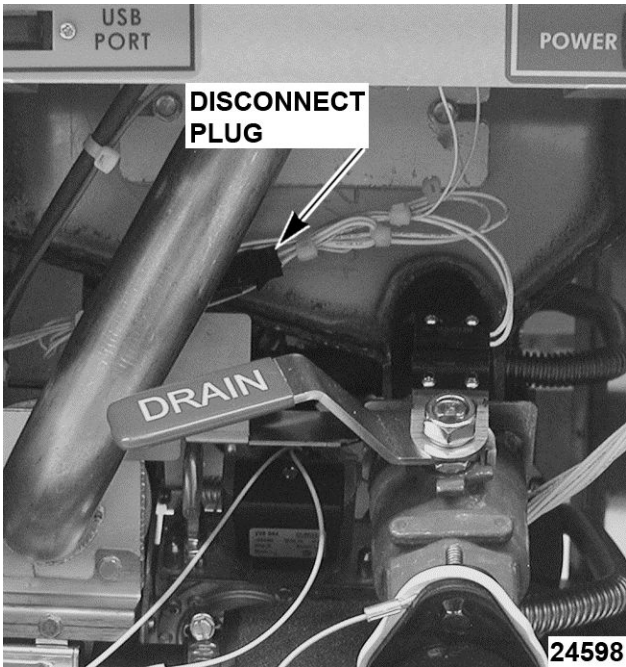

Fig. 47

3. Test the probe using a VOM to measure resistance. Connect the meter leads to the wires removed in step 2.
 - A. If the measured resistance values are within the allowable range, the probe is functioning properly. Reverse procedure to install.
 - B. If the measured resistance values are outside the allowable range, install a replacement probe and check for proper operation.

TEMPERATURE (°F)	RESISTANCE (Ω)
77	90,000 - 110,000
350	604 - 836
415 ¹	302 - 369
460 ²	191 - 233
¹ High temperature alarm level for the cooking controls	
² Shorted probe equivalent temperature	

COOKING CONTROL CALIBRATION

NOTE: Verify condition of temperature probe as outlined under TEMPERATURE PROBE TEST before proceeding.

1. Check the level of shortening in fry tank. The level must be between the MIN & MAX fill lines before proceeding.
2. Allow shortening to cool below 300°F.
3. Place a thermocouple in the geometric center of the fry tank one inch below the shortening surface.
4. Set the cooking control to 350°F and turn the fryer on.
5. Monitor the heat indicator lamp. When cooking control is calling for heat, lamp will be on. If cooking control is satisfied, lamp will be off.

Analog Control - Heat light is to right of zero on temperature scale.

Solid State Control - Decimal point of first character indicates heat on when lit.

Computer Control - Two LED lamps on the Oil Temp key that indicate heat on.

NOTE: Agitate the shortening, to eliminate any cold zones.

- A. Allow cooking control to cycle three times to stabilize shortening temperature.
 - B. Record meter reading from thermocouple when the cooking control cycles off and on for at least two complete heating cycles.
6. Calculate the average temperature by adding the temperature reading when the heat lamp goes out to the temperature reading when the heat lamp comes on & divide this answer by 2.

[Temp. (Lamp off) + Temp. (lamp on)] ÷ 2 = Average Temp. Example: 360° + 340° ÷ 2 = 350°F.

The average temperature should be 350°F (± 5°F).

- A. If the average temperature reading is within tolerance, cooking control is properly calibrated.
- B. If the average temperature reading is out of tolerance, perform the following:
 - 1) *Analog Control* - Remove knob and turn adjustment screw counterclockwise to increase temperature and clockwise to decrease temperature.
 - 2) *Solid State Control* - Adjust OFFSET TEMPERATURE.
 - 3) *Computer Control* - Adjust OFFSET TEMPERATURE.

7. Repeat the average temperature calculation for up to three attempts. Allow the cooking control to cycle at least two times between adjustments before performing the calculation.
8. If calibration is unsuccessful, the cooking control may be malfunctioning and cannot be adjusted properly. Install a replacement cooking control and check calibration.

FLAME SENSE CURRENT CHECK PRIOR TO 12/1/12

⚠ WARNING Certain procedures in this section require electrical test or measurements while power is applied to the machine. Exercise extreme caution at all times. If test points are not easily accessible, disconnect power and follow lockout / tagout procedures, attach test equipment and reapply power to the test.

1. Remove cover of power supply box.
2. Locate red flame sense wire.

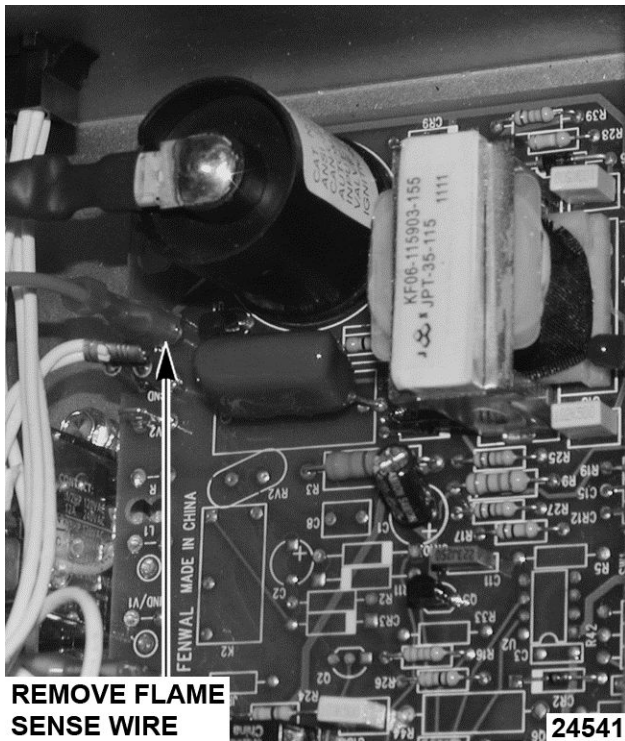

Fig. 48

3. Remove the red flame sense wire.
4. Place one Microamp meter lead on the red wire.
5. Place the other meter lead on the terminal you removed the red flame sense wire from.
6. Power up the fryer and have it call for heat.
7. You should receive a minimum Microamp reading of at least 1.0 microamp.
8. If the reading is greater or equal to the value given, then the flame sense current is within tolerance.
9. If the reading is lower than the value given, then troubleshoot the flame sense circuit.

NOTE: If the reading is below 0.0 microamps, reverse the meter leads and take another reading.

FLAME SENSE CURRENT CHECK AFTER 12/1/12

⚠ WARNING Certain procedures in this section require electrical test or measurements while power is applied to the machine. Exercise extreme caution at all times. If test points are not easily accessible, disconnect power and follow lockout / tagout procedures, attach test equipment and reapply power to the test.

1. Remove cover from power supply box.

2. Locate two pins (FC- and FC+) on side of the ignition/ blower control board.

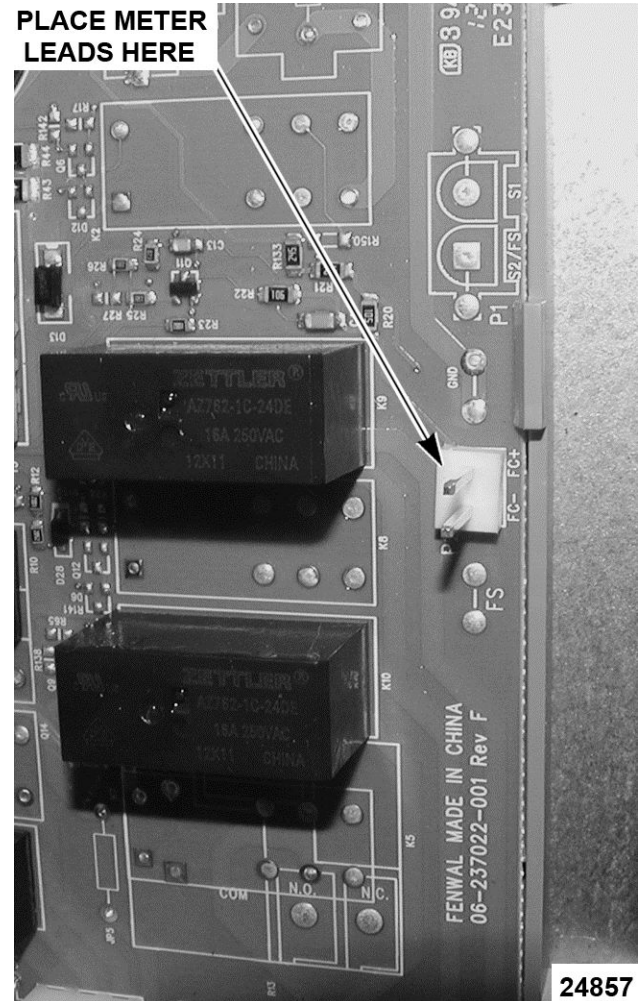

Fig. 49

3. Set your multi meter for Microamps and place meter leads on two pins.
4. Restart the fryer and read the microamps as the fryer is sparking.

NOTE: The only time you will be able to read the microamps is when the fryer is sparking. When the spark quits the reading will go away. You may only have several seconds to obtain this reading.

5. The flame sense current must be at least 2.0 to 3.0 microamps, and the reading must be steady.
6. If reading is below 1.3 microamp or unsteady, check pilot flame and electrical connections.

ELECTRONIC IGNITION CONTROL

NOTE: This procedure applies to all fryers.

Ignition Module Lockout

This happens when fryer is unable to detect flame sense. The electrode will try to ignite one time. When

flame has not been detected within 5 seconds red light on ignition module will blink.

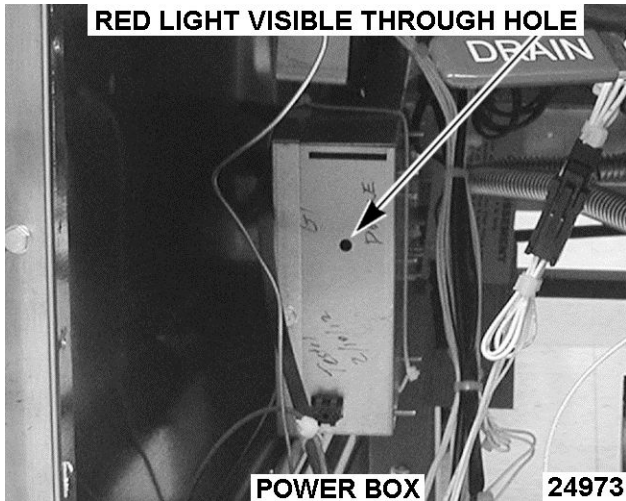

Fig. 50

"A" style controller: Red light will blink and blower will continue to run until power has been turned off.

"C" and "D" style controllers: Red light will continue to blink, but blower will shut down after a number of seconds and a loud "beep" will continue to sound until fryer is powered down.

Electronic Ignition System



WARNING Certain procedures in this section require electrical test or measurements while power is applied to the machine. Exercise extreme caution at all times and follow Arc Flash procedures. If test points are not easily accessible, disconnect power and follow Lockout/Tagout procedures, attach test equipment and reapply power to test.

1. Access burner electrode.
2. Remove ignition wire from burner electrode.
3. Fasten metal end of ignition wire about 1/4 away from a grounded metal surface on fryer.
4. Try to light the burner.
5. You should be able to see a spark. If no spark, check ignition module in power supply box.

MODULATING GAS VALVE ADJUSTMENTS



WARNING Disconnect the electrical power to the machine and follow lockout / tagout procedures.

WARNING Shut off the gas before servicing the unit.

WARNING All gas joints disturbed during servicing must be checked for leaks. Check with a soap and water solution (bubbles). Do not use an open flame.

The modulating gas valve is adjusted at the factory and requires no adjustments. If the modulating gas valve needs to be replaced, the new gas valve from the parts depot will be adjusted properly and will only need to have the gas pressure verified coming into the gas valve.

All fryers built after 12/1/12 will have gas regulators installed on the incoming gas line. The gas pressure on the new gas vales will not have to be checked.

BASKET LIFT ARM ADJUSTMENT

1. With shortening at room temperature, verify the shortening level is between MIN & MAX lines in fry tank. Add shortening as needed.

NOTE: Shortening will expand when heated. Do not fill the fry tank past the MAX line.

2. Turn power switch on and set temperature to 350°F. Allow the shortening to reach set temperature.
3. Check basket lift operation.
 - A. If necessary, adjust as outlined below.
4. When basket is in the up position, the bottom of the basket should be out of the shortening. When basket is in the down position, the bottom of the basket should clear the crumb screen and the product should be submerged.
 - A. To adjust, remove basket arm from lift shaft, loosen stop nut and turn height adjustment bolt to raise or lower basket arm as required. Both baskets should be same height.
 - B. Tighten stop nut when complete.

NOTE: If adjustment is to low, when the basket is lowered, it will disengage from basket arm



Fig. 51

SOLID STATE CONTROL

Operation

Use service information in this section when servicing a fryer with a solid state control. Refer to instruction manual for specific operating instructions.

NOTE: In operator programming mode, control can be reset to it's default values by pressing the TEMP key for 2 seconds.

Service Programming

Solid state control Service Mode is used to perform system diagnostic tests or edit programs that affect the fryers operation.

Error Messages

Refer to ALARM MESSAGES at end of section.

Enter Service Mode

NOTE: Control heat demand output signal is off and heat/ignition status input signal is ignored.

1. Cycle power switch. When the program version number is displayed, press PROGRAM key to enter Service Mode.
 - A. Beeper chirps on each successful keypress.
2. To scroll through each of the program items, press PROGRAM key and release.
 - A. To reset all service mode program items to factory default, press and hold TEMP key for 2 seconds.
3. To exit Service Mode and save selections, press PROGRAM key and hold for 1 second. Fryer returns to normal operation and display shows the current heating mode based on shortening temperature:
 - MELT L (liquid; default) or Melt S (solid) if shortening temperature is below 135°F.
 - HEATING if no melt is selected and shortening temperature is below set point.
 - Fryer set point temperature if actual shortening temperature is within set point range.

Control Programming		
PROGRAM ITEM	KEY SEQUENCE	DISPLAY ¹
Brand Name	Press left or right basket to select display name.	Hobart or Vulcan
Temperature Display Mode	Press left or right basket to select temperature unit of measure.	DEG F OR C
Boil or Filter Function	Press left or right basket to select fryer type. Boil key overlay = stand alone fryer. Filter key overlay = filtering system fryer batteries.	BOIL OR FILTER
Fryer Type	Press left or right basket to select fryer energy source (electric or gas heat) Gas Star must be selected for VK and TR Fryers ⁴	ELECTRIC or GAS or Gas* (Star)
Calibration Offset	Press left basket to increase or right basket to decrease offset temperature (range -20 to 20) ²	OFS 00F (always in °F)

Control Programming			
PROGRAM ITEM	KEY SEQUENCE	DISPLAY ¹	
Low Cook Temp Lockout	Press left basket to increase or right basket to decrease cooking cycle lockout temperature (range 30 to 50F) ² NOTE: Prevents cook timers from starting if actual shortening temperature is not within the lockout temperature setting.	LOCKO 40 (always in °F)	
NOTE: The program items listed below are for <i>verifying settings only</i> . Do not change the default setting for these program items.			
PROGRAM ITEM	KEY SEQUENCE	DISPLAY ¹	
Instant On Time (heat)	Press left basket to increase or right basket to decrease instant on time. NOTE: At the start of a cook cycle, the heat output will be activated for this time (range 0 to 20 seconds).	INSTO 20	
Melt Cycle On/ Off Times	Press left basket to increase or right basket to decrease melt cycle time. ³		
	Gas Fryers Adjustment Range: Melt ON - 0 to 20 seconds; Melt OFF - 0 to 30 seconds.	MLTG 1 16 (Liq) 08 (Sol)	(Melt ON)
		MLTG 0 18 (Liq) 26 (Sol)	(Melt OFF)
		MLTE1 04 (Liq) 02 (Sol)	(Melt ON)
Electric Fryers Adjustment Range: Melt ON - 0 to 2 seconds; Melt OFF - 10 to 30 seconds.	MLTE0 11 (liq) 13 (Sol)	(Melt OFF)	
Proportional Offset	Press left basket to increase or press right basket to decrease proportional offset (range 0 to 30).	POFST 02	
Proportional Gain	Press left basket to increase or right basket to decrease proportional gain (range 0 to 30).	PGAIN 24	
Derivative Gain	Press left basket to increase or right basket to decrease derivative gain (range 0 to 30).	DGAIN 20	
Integral Gain	press left basket to increase or right basket to decrease integral gain (range 0 to 30).	IGAIN 08	
Integral Limit	Press left basket to increase or right basket to decrease integral limit (range 0 to 255).	ILIM 255	

Control Programming		
PROGRAM ITEM	KEY SEQUENCE	DISPLAY ¹
NOTES	<p>¹ Default value shown in bold type.</p> <p>² Temperature will change in one degree increments, accelerating if the button is held.</p> <p>³ Time will change in one second increments, accelerating if the button is held.</p> <p>⁴ Gas* and Gas Star are the same value. The Solid State Display cannot show an asterick(*).</p>	

Display Test

1. Cycle power switch. When FRYERS is displayed, press PROGRAM key.
 - A. Display shows DSP TEST.
 - B. Press PROGRAM key again to light all the display segments in the first character.
 - C. Continue pressing PROGRAM key until the display segments for all eight characters are tested.

2. To exit test, press and hold the PROGRAM key for one second.

Alarm Messages

Alarms take precedence over any other controller mode or function (except drain valve function).

ALARMS	DESCRIPTION
OPEN PROBE	<p>If an open probe is detected, the heat demand (heat on) and basket lift outputs are disabled. Any cooking in progress is cancelled and all operator buttons are disabled. the display alternates OPEN PROBE and the electronic alarm will sound continuously.</p> <p>NOTE: A temperature of 460°F is an open probe equivalent.</p>
SHORTED PROBE	<p>If a shorted probe is detected, the heat demand (heat on) and basket lift outputs are disabled. Any cooking in progress is cancelled and all operator buttons are disabled. The display alternates SHORTED PROBE and the electronic alarm will sound continuously.</p> <p>NOTE: A temperature of 460°F or greater is a shorted probe equivalent.</p>
HI TEMP	<p>If the temperature is greater than or equal to 415°F, the heat demand (heat on) and basket lift outputs are disabled. Any cooking in progress is cancelled and all operator buttons are disabled. The display alternates HIGH TEMP and the electronic alarm will sound continuously. Normal fryer operation resumes when the temperature drops below the high temperature alarm level.</p>
IGNITION STATUS (gas models only)	<p>If the ignition status input to the control is not active (24VAC = active), the display shows NO PILOT. If the input remains inactive for greater than 90 seconds, the display will alternate IGNITION LOCKOUT, the electronic alarm will sound continuously, and the controller will be disabled (all outputs including heat demand off) until power is cycled.</p>

ALARMS	DESCRIPTION
DRAIN VALVE INTERLOCK (DVI) Filtering System Fryer Batteries (Filter Key)	<p>When drain valve is opened, the DVI switch contacts open, and the 24VAC input to the control is removed. The heat demand (heat on) and basket lift outputs are disabled. Any cooking in progress is cancelled and all operator buttons are disabled. The display will show DRAINING.</p> <p>Press FILTER key and hold for 3 seconds to begin filtering (pump on). Control is signaled that filtering has started.</p> <p>When the drain valve is closed, the DVI switch contacts close, and the 24VAC input to the controller is restored. The heat demand (heat on) and all operator buttons will remain disabled and the display will show FILL VAT.</p> <p>To resume operation, allow the tank to fill with shortening between the MIN and MAX lines. Press FILTER key to turn the pump motor off. Control is signaled that filtering has stopped and the tank is full, Display will ask VAT FULL HIT TEMP. Press TEMP key after confirming the shortening is at the proper level and to resume heating.</p>
DRAIN VALVE INTERLOCK (DVI) Stand Alone Fryers (Boil Key)	<p>When drain valve is opened, the DVI switch contacts open, and the 24VAC input to the control is removed. The heat demand (heat on) and basket lift outputs are disabled. Any cooking in progress is cancelled and all operator buttons are disabled. The display will show DRAINING.</p> <p>When the drain valve is closed, the DVI switch contacts close, and the 24VAC input to the controller is restored. The heat demand (heat on) and all operator buttons will remain disabled and the display will show FILL VAT HIT TEMP.</p> <p>To resume operation, allow the tank to fill with shortening between the MIN and MAX lines. Press TEMP key. Display will ask VAT FULL HIT TEMP. Press TEMP key a second time after confirming the shortening is at the proper level and to resume heating.</p>
PROGRAM LOST RECHECK	<p>When the program has detected errors in the data that is stored in the controls non volatile memory (EEPROM), the control will automatically reload the factory default settings. Display will alternate the alarm message until program mode is entered then exited or power is cycled to control.</p>
IGNITION STATUS GAS Selected incorrectly under service settings - type	<p>After 20 seconds in normal operation mode. IGNITION LOCKOUT will be shown on the display and the alarm will sound continuously.</p> <p>Enter SERVICE SETTINGS and select GAS* as the type.</p>

COMPUTER CONTROL

Operation

For operating instructions and programming, refer to [OPERATOR MANUAL](#) and computer controls programming start guide.

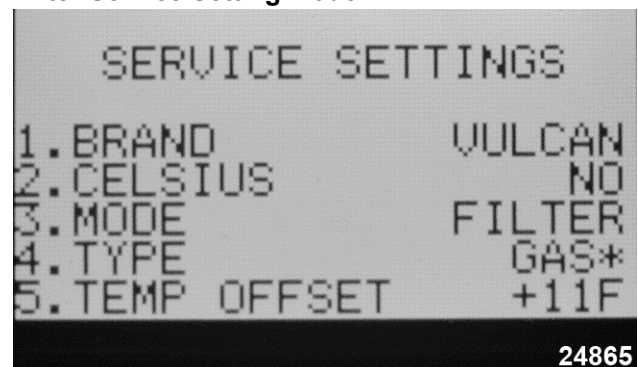

Fig. 52

Service Programming

The computer controls service settings mode is used to select the settings that affect fryer operation and to perform fryer diagnostic tests.

Enter Service Setting Mode



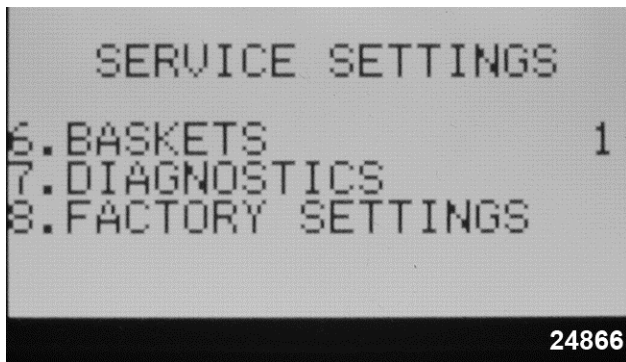

Fig. 54

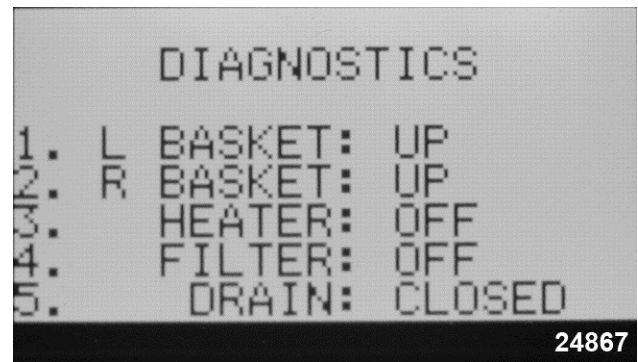

Fig. 55

NOTE: The controls heat demand output signal is off and the heat/ignition status input signal is ignored if the fryer is in cook mode or idling.

1. Turn power switch on and when the program revision is displayed, press PROGRAM to enter Service Setting Mode.
 - A. The SERVICE SETTINGS are shown on the left and right display screens.
2. Verify the settings shown on the display screen are correct for the fryer being serviced.
3. To change a service setting.
 - A. Press the desired product number key (1 thru 6) on the control panel that corresponds to the service setting number on the display screen.
 - 1) Beeper chirps on each successful key press and all LED's are off. When a service item is selected, only the keys required to change the setting are active.
 - B. Press toggle key to alternate between available selections, or use product number keys where indicated to enter a value. The current selection will be "blinking".
 - C. Press PROGRAM key to save the selection - "Blinking" stops.
 - D. Access the other service settings as necessary.
4. To enter DIAGNOSTICS mode, press product number key 7 on the control panel.

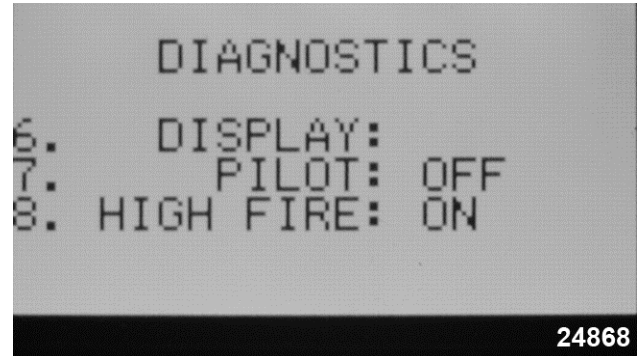

Fig. 56

- A. Press the desired product number key (1, 2, 3, 4, & 6) on the control panel that corresponds to the diagnostic test number on the display screen to check the output signal to the component.
 - 1) Press the same product number key again to turn the output off.

NOTE: Item 5 (drain) displays the real time status and does not require pressing the corresponding product number key. Item 3 (heater) - The output signal will be active for 3 seconds (heat on) then turn off.

- B. For item 6 DISPLAY: - change the setting as desired.
 - 1) Press product number key 6 to access the display screen adjustment settings.
 - 2) Press the left or right arrow key on the PROGRAMMING MENU SELECTION screen to select the screen to adjust. Display shows "THIS LCD SELECTED".



Fig. 57

- 3) To adjust the selected screen:
 - a. BACKLIGHT - Press toggle key to turn display backlight ON or OFF.
 - b. PIXEL MODE - Press product key number 1 two times to change display from white background with black letters to black background with white letters. Press the key again to change it back to original setting.

- c. CONTRAST - Press the L key on the keypad to lower the contrast or press the R key on the keypad to raise the contrast.
- 4) Press PROGRAM key to return to DIAGNOSTICS MODE.
5. To exit SERVICE SETTINGS MODE and return to normal operation, keypress PROGRAM key.
 - A. Display reverts to product menu items.

SERVICE SETTINGS	KEY SEQUENCE	DISPLAY ITEM FLASHES ¹	DESCRIPTION
1. Brand	Press 1 to change brand name. Press toggle key to select HOBART or VULCAN. Press PROGRAM Key to save the selection.	VULCAN	Brand name at power on
2. Celsius	Press 2 to change temperature scale. Press toggle key to select NO or YES. Press PROGRAM Key to save the selection.	NO	Temperature °F/°C No = Fahrenheit Yes = Celsius
3. Mode	Press 3 to change fryer mode. Press toggle key to select BOIL or FILTER. Press PROGRAM Key to save the selection.	Boil	Boil or Filter Boil key = Stand alone fryer Filter key = Filter system battery
4. Type	Press 4 to change energy source. Press toggle key to select ELECTRIC, GAS or GAS*. NOTE: VK and TR Gas Fryers <u>MUST</u> be set to GAS*. Press PROGRAM Key to save the selection.	ELECTRIC	Electric or Gas

SERVICE SETTINGS	KEY SEQUENCE	DISPLAY ITEM FLASHES ¹	DESCRIPTION
5 Temp Offset	<p>Press 5 to change offset temperature.</p> <p>Press toggle key to change offset value to (+) or (-) (positive or negative).</p> <p>Enter the offset value using the number keys on the keypad.</p> <p>NOTE: Offsets the actual oil temp sensed by the temperature probe during calibration. Enter a positive number to decrease the actual oil temperature; or a negative number to increase the oil temperature.</p> <p>Press PROGRAM Key to save the selection.</p>	OFF 00 F (always in °F)	Degrees Fahrenheit and positive zero are the defaults.
6. Baskets	<p>Press 6 to change the number of basket lifts.</p> <p>Press toggle key to select 0, 1, or 2.</p> <p>Press PROGRAM Key to save the selection.</p>	2	Display shows 0, 1 or 2
7. Diagnostics	Press 7 to enter diagnostic mode (outputs for heat, basket lifts and cooking timers remain off).	—	DIAGNOSTICS (shown on display screen)
1.) L Basket	Press 1 to toggle left basket lift output to lower the lift.	DOWN	Lowers basket
	Press 1 again to raise the lift.	UP	Raises basket
2.) R Basket	Press 2 to toggle right basket lift output to lower the lift.	DOWN	Lowers basket
	Press 2 again to raise the lift.	UP	Raises basket
3.) Heater	Press 3 to turn heat output ON for 3 seconds only. OIL TEMPERATURE LED's light with heat demand.	On then OFF	Gas burner or heating elements turn on then off.
4.) Filter	Press 4 to turn filter output ON.	ON	Pump motor on
	NOTE: Filtering system fryer batteries only		
	Press 4 again to turn output OFF.	OFF	Pump motor off
5.) Drain	Display indicates the position of the drain valve. (DVI switch input to control) (keypress not required). Manually change valve position to test, and display will update.	CLOSED	
	Drain valve open	OPEN	
	Drain valve closed	CLOSED	

SERVICE SETTINGS	KEY SEQUENCE	DISPLAY ITEM FLASHES ¹	DESCRIPTION
6.) Display	<p>Press 6 to adjust the left and right display screen settings. Refer to LCD display screen picture under ENTER SERVICE SETTINGS MODE.</p> <p>Press the left or right arrow key on control panel to select the screen to adjust.</p> <p>To adjust the selected screen:</p> <ul style="list-style-type: none"> • BACKLIGHT - Press toggle key to turn display backlight ON or OFF. • PIXEL MODE - Press product key number 1 two times to change display from white background with black letters to black background with white letters. Press the key again to change it back to original setting. • CONTRAST - Press the L key on the keypad to lower the contrast or press the R key on the keypad to raise the contrast. 	N/A	THIS LCD SELECTED
Exit Diagnostic and Service Mode	Press PROGRAM Key to exit the selected DIAGNOSTICS test and return to Service Settings Mode.	N/A	SERVICE SETTINGS (shown on display screen)
NOTES:	¹ Default values shown in bold.		

Alarm Messages

The alarms take precedence over any other controller mode or function (outputs off, active timers canceled).

ALARMS	DESCRIPTION
PROBE FAULT	<p>If a temperature probe fault occurs, the alarm sounds continuously and the display shows PROBE on the left display and either OPEN or SHORT on the right display. This alarm state will remain until the fault clears or power switch is cycled.</p> <ul style="list-style-type: none"> • OPEN - Probe detects temperature less than 40°F. • SHORTED - Probe detects temperature greater than 460°F.
IGNITION STATUS GAS -Selected under service settings - Type.	<p>If the ignition status input is not present, both displays show IGNITION LOCKOUT. If the input comes back in less than 8 seconds, the displays will revert to normal operation.</p> <p>If the input remains inactive for more than 90 seconds, IGNITION LOCKOUT will be shown on the left display and CHECK GAS SUPPLY will be shown right display, and the alarm will sound continuously. This alarm state will remain until power switch is cycled.</p>
IGNITION STATUS GAS Selected incorrectly under service settings - Type.	<p>After 20 seconds in normal operation mode, IGNITION LOCKOUT will be shown on the left display and CHECK GAS SUPPLY will be shown right display, and the alarm will sound continuously.</p> <p>Enter SERVICE SETTINGS and select GAS* as the type</p>

DISPLAY, LED AND KEYPAD TEST - COMPUTER CONTROL

1. Press and hold the 5 key while turning power on to Initiate test. Release the 5 key during display of software revision level and all LED's and display segments should light.
2. For each number key (1-9, & 0) pressed, the corresponding value is displayed in each character position on the left and right display.
(i.e.5 key shows 55555555 55555555).

NOTE: Beeper chirp's for as long as key is held.

3. For each function key pressed, the following values are displayed in each character position on the left and right display:

L (left)	L Cook
R (right)	R Cook
TEMPERATURE	Temp
PROGRAM (V)	Program
TOGGLE	Toggle
BOIL	B (single floor model fryers)
FILTER	D (Kleenscreen fryers)
LEFT TIME	< (Left Arrow)
RIGHT TIME	> (R Arrow)

4. Turn power off to exit test.

BLOWER CONTROL BOARD SETTINGS



WARNING Disconnect the electrical power to the machine and follow lockout / tagout procedures.

NOTE: This procedure for fryers built before 12/1/2012.

Whenever you have problems with the blower motor make sure the following adjustments are correct.

1. **SW2:** Set the SW2 potentiometer to the number 2 setting.
2. **SW4:** Set the SW4 potentiometer to the number 4 setting.
3. **Dip switches:** Set the fourth switch (the one closest to the potentiometers) to the up position.

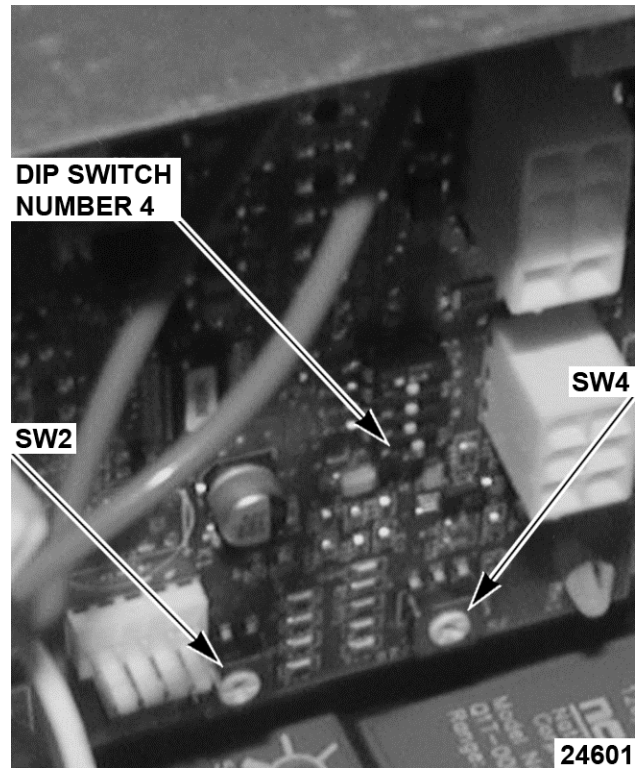

Fig. 58

NOTE: For fryers built after 12/1/2012, there are no adjustments for blower settings, The Ignition/Blower control board is preprogrammed. If a fryer built before 12/1/12 has been converted to the new Ignition/Blower control board, there will be no adjustments.

HIGH/LOW FIRE TIMER SETTING



WARNING Disconnect the electrical power to the machine and follow lockout / tagout procedures.

NOTE: This procedure is for fryers built before 12/1/2012

Whenever you have problems with high or low firing of the burner make sure the following adjustments are correct.

NOTE: To set the fire timers use a jeweler's flathead screwdriver.

NOTE: The timer closest to the ignition module is the low fire timer, and the one closest to the bottom is the high fire timer.

1. **Low fire timer:** Set the low fire timer for 2 seconds.
2. **High fire timer:** Set the high fire timer for 8 seconds.

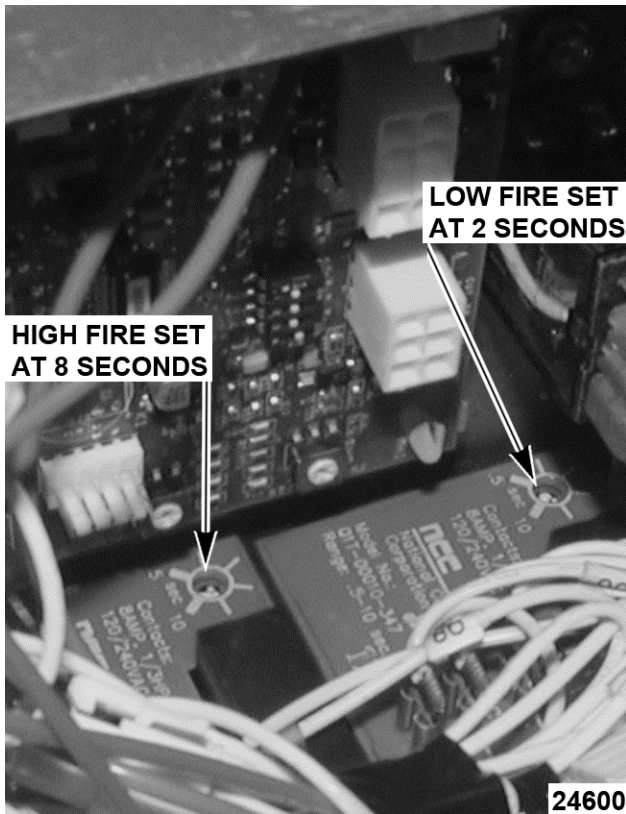

Fig. 59

NOTE: For fryers built after 12/1/12, the fire timers are replaced by a Ignition/Blower control board. The high and low fire time settings are programmed into the control board. If a fryer built before 12/1/12 has been converted to the new Ignition/Blower control board, there will be no adjustments.

AIR FILTER

A dirty air filter will prevent the correct amount of air intake for the blower. The results are poor combustion resulting in the fryer "puffing" severely.

To clean the air filter, remove the filter by pulling it off. The clamp is only hand tightened. Clean air filter in dishwasher or in sink with hot soapy water. Make sure air filter is completely dry prior to reinstalling, making sure that the filter is snug onto the blower intake. Make sure **NOT** to tighten the clamp more than hand tight.

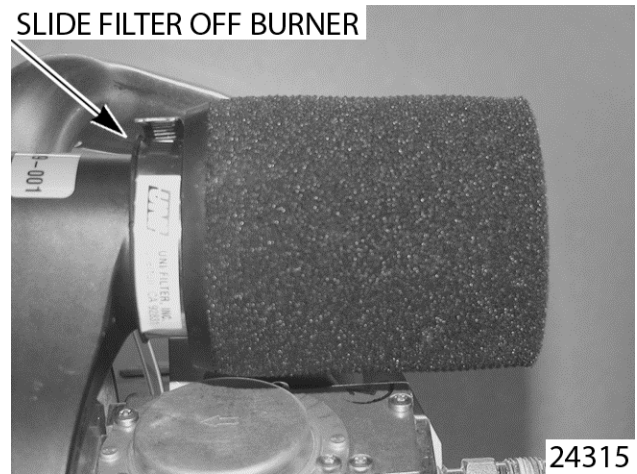

Fig. 60

SPARK GAP SETTING BEFORE 12/1/12

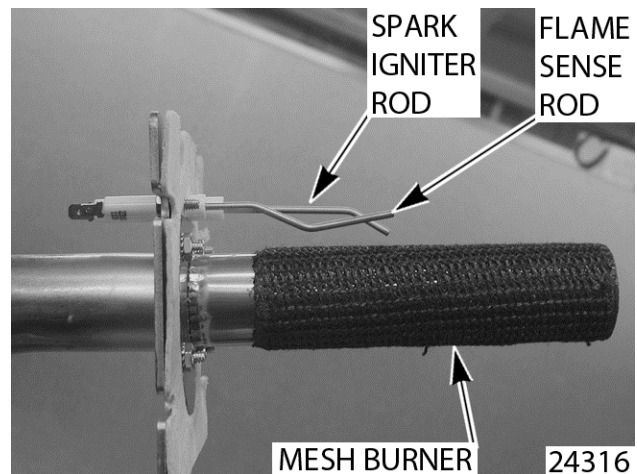

Fig. 61

The spark igniter rod should be set between 1/8" and 3/16" away from the mesh burner. This gap will allow the igniter to produce the optimal spark required to ignite the burner.

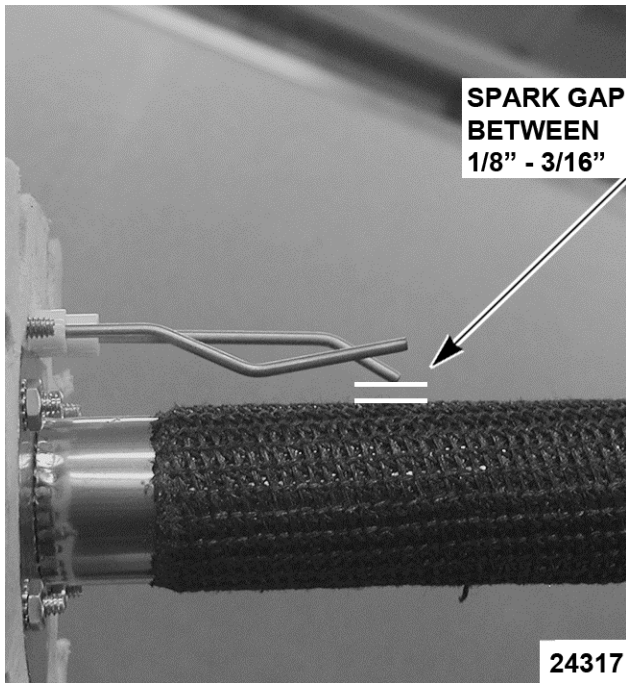

Fig. 62

If the spark igniter rod is not adjusted correctly the gas could build up in the burner assembly and cause a delayed ignition of the burner. The resulting "puffing" could result in damage to the fryer.

NOTE: If the power supply box has been converted to the new controls, the spark igniter rod should be replaced with the new style spark rod.

**SPARK GAP SETTING AFTER
12/1/12**

1. Insure the spark igniter is installed properly on the burner.
2. The spark igniter rod should be set touching mesh or with a maximum gap between rod and burner mesh of 1/16 of an inch.

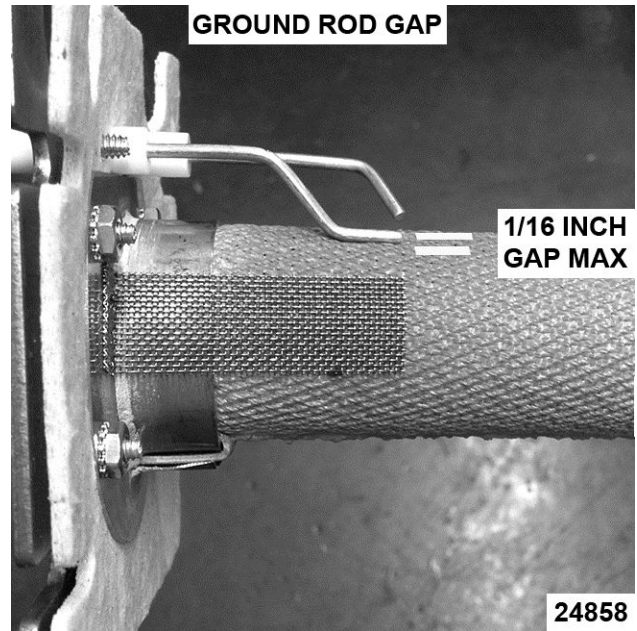

Fig. 63

3. There should be a gap of 1/8 to 3/16 of an inch between igniter rod and ground rod.

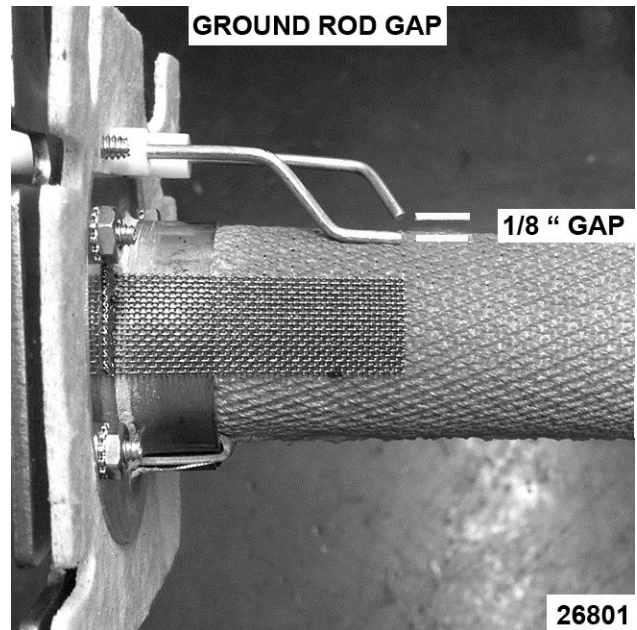

Fig. 64

4. This igniter sparks to the ground rod. To insure we have a proper ground, we put a wire on the ground rod terminal and secure it to burner.

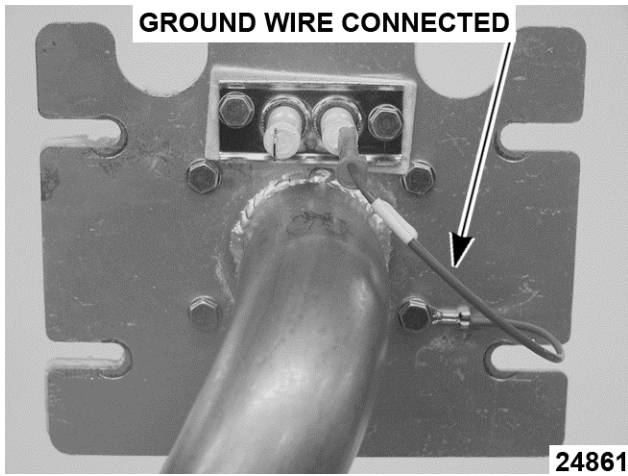

Fig. 65

ELECTRICAL OPERATION

COMPONENT FUNCTION - FRYER CONTROLS

Ignitor/ Ground (After 12/1/12)	Ignites the gas burner and senses the presence of a flame. The flame presence generates a micro-amp flame sense current that is rectified to the ignition control module.
Ignition/Blower control board (After 12/1/12) ...	Provides the output signal interface from the cooking control to operate the burner blower motor in low or high speeds, controls and monitors gas burner ignition. Monitors the presence of a flame and supplies an ignition status input signal to the cooking control,
Analog (A), Solid State (D) or Computer Cooking Control (C) ...	Monitors and evaluates input signals to the control: Activates heat output signal to maintain shortening temperature; counts product cook time(s) and signals the electronic alarm at the end of a cooking cycle; activates the left and right lift output signal to operate the basket lifts(s); and activates filter output signal to power the fill solenoid valve. NOTE: By utilizing the same wiring harness connections D and C controls are interchangeable between fryers.
Control Interface Board (D and C fryers only)	Provides the output signal interface from the cooking control to regulate gas heating, basket lift operation and fill solenoid valve operation. The board components consist of a heat control Triac and K1, K2 & K3 N.O. relays.
Transformer	Supplies 24VAC to the cooking control, also supplies power to ignition control module. Transformer is energized when power switch is turned on.
Power Switch	Supplies power to control circuit for fryer operation and filtering.
Modulating Gas Valve ...	Allows the gas flow to modulate between low and high flame when gas valve coil is energized.
High Limit Thermostat ...	Prevents the shortening from reaching temperatures over 450°F (auto reset @ 415°F). Serves as a backup to the cooking control's high temperature alarm setting of 415°F (normal operation resumes when temperature falls below this point).
Temperature Probe ...	Senses temperature of shortening. Converts the temperature into a resistance value which is monitored by the cooking control. The probe is an RTD (resistance temperature detector) of the Thermistor type. As temperature increases the resistance value decreases.
Drain Valve Interlock Switch (DVI)	A magnetic reed switch mounted on the manual drain valve that supplies a drain valve position signal (open/closed) to the cooking control. When drain valve is open, the drain interlock input to the control is removed (magnetic reed switch contacts open). This prevents gas burners from coming on with the fry tank empty.
Ignition Control Module (Before 12/1/12)	Controls and monitors gas burner ignition. Monitors the presence of a flame and supplies an ignition status input signal to the cooking control.
Ignitor/Flame Sense (Before 12/1/12)	Ignites the gas burner and senses the presence of a flame. The flame presence generates a micro-amp flame sense current that is rectified to the ignition control module.
Burner Time Delay Relays (Before 12/1/12)	These relays are used in conjunction with the burner either in high or low fire settings.
Blower Relay (Before 12/1/12)	When the relay coil is energized, it supplies voltage to operate the burner blower motor.
Blower Control Board (Before 12/1/12)	Provides the output signal interface from the cooking control to operate the burner blower motor in low or high speeds. The board components consist of 4 dip switches, SW2 and SW4.

COMPONENT FUNCTION - KLEENSCREEN FILTER CONTROLS

- Fill Solenoid Valve** ... When energized by filter key, the solenoid valve opens to allow the flow of shortening thru filtering system.
- Pump Motor** Operates pump to circulate shortening through filtering system.
- Drain Valve Interlock Switch (DVI)** A magnetic reed switch mounted on the mechanical discard valve that closes when discard valve handle is extended to discard the shortening. Prevents R2 filter relay N.C. contacts from supplying power to the fill solenoid valve when filter key is pressed.
- R1 Pump Motor Relay** ... When 24VAC relay coil is energized by filter key, supplies 120VAC to pump motor; and fill solenoid valve (thru R2 fill relay N.C. contacts).
- R2 Fill Relay** When 24VAC relay coil is energized by filter key, supplies 24VAC to the fill solenoid valve to open the valve and allow shortening to flow thru filter system.

COMPONENT LOCATION

BEHIND FRYER DOOR

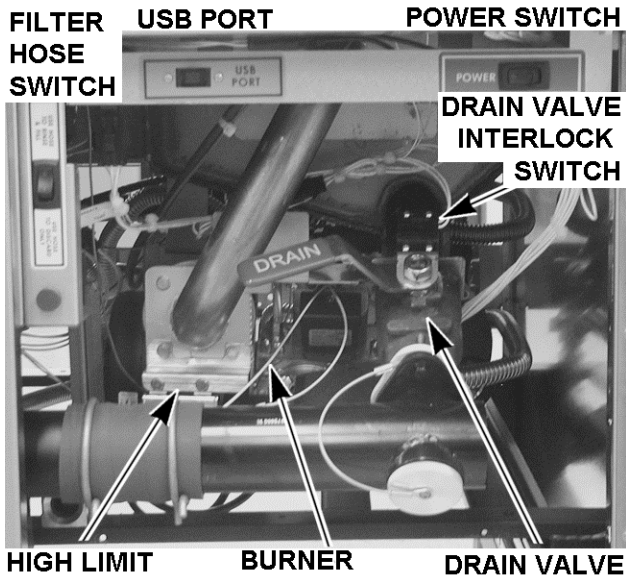

POWER SUPPLY BOX - RIGHT SIDE OF EACH FRYER SECTION 24872
 Fig. 66

POWER SUPPLY BOX

TRANSFORMER
BLOWER CONTROL BOARD
IGNITION MODULE

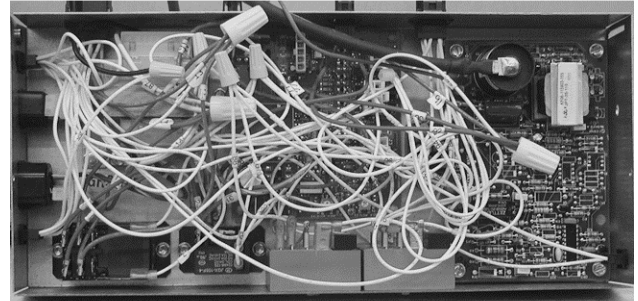

FILTER RELAYS
TIME DELAY RELAYS
24545
 Fig. 67

NEW POWER SUPPLY BOX (AFTER 12/1/12) TRANSFORMER

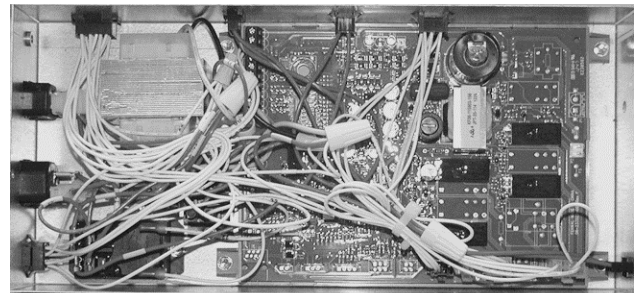

FILTER RELAYS
IGNITION/BLOWER CONTROL BOARD
24873
 Fig. 68

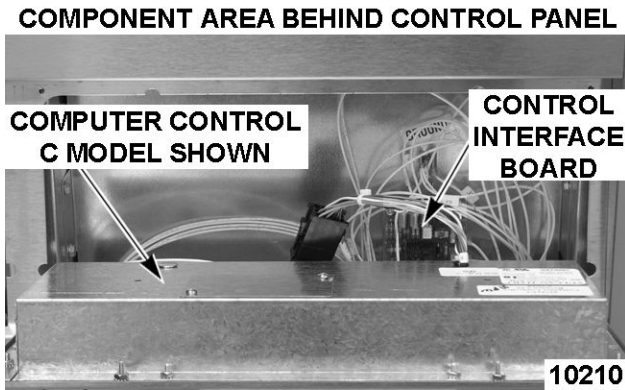

Fig. 69

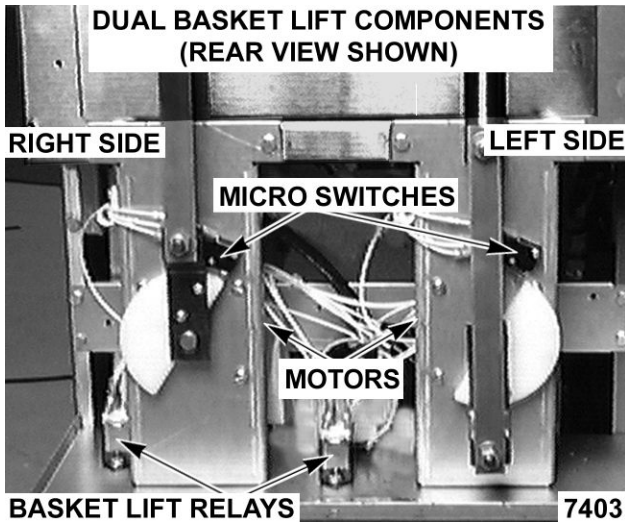

Fig. 70

SEQUENCE OF OPERATION - A SERIES - AFTER 12/1/12

Refer to the schematic diagrams for Analog Control operation.

NOTE: If the Solid/ Liquid switch is set to Solid, the control will cycle the heat on and off in short intervals until the shortening is heated to 135°F.

Melt Cycle times	
Liquid	8 sec on and 18 sec off
Solid	16 sec on and 18 sec off

1. Conditions:
 - A. Fryer connected to correct supply voltage and properly grounded.
 - B. Incoming gas supply is on and manual gas valve turned on.
 - C. Power switch to the fryer section in the off position.
 - D. Solid/Liquid switch set to correct position.

- E. Shortening at proper level in fry tank and below last set point temperature used.
- F. Manual drain valve closed (drain valve interlock switch N.O. is closed).
- G. High limit thermostat closed.
2. Turn power switch on.
 - A. 24VAC transformer energized.
3. Analog control is powered 24VAC.
4. Start switch is closed (momentary).
5. If shortening temp is below 135°F then melt cycle will operate.
6. Temperature goes above 135°F and control calls for heat.
 - A. 3 sec prepurge.
 - B. Spark sent to igniter.
 - 7 sec trial for ignition. If flame not detected after 8 sec, Lockout.

NOTE: System remains locked out until the power switch is cycled to reset system and restart trial for ignition cycle. (Wait 5 minutes for gas to dissipate)

- 2 sec after flame detected, burner blower motor in low speed and low fire initiated.
- C. Once burner flame is present, burner blower motor goes from low speed to high speed.
 - D. Ignition module provides ignition status input signal to control.
 7. Cooking control evaluates input signals from: Ignition status, drain valve interlock, and temperature probe.

- A. Ignited burner heats shortening in fry tank.

NOTE: As long as the ignition module senses a flame, the internal main voltage (MV) contacts (N.O.) on the ignition module remain closed, and the gas valve stays on.

8. Shortening reaches set temperature.
 - A. Cooking control de-activates heat output (24VAC).
 - 1) Gas valve coil de-energized and valve closes.
 - 2) Gas flow stops and burner goes out.
9. When fryer calls for heat again, ignition sequence will begin at step 6A.

SEQUENCE OF OPERATION D AND C SERIES

Refer to SCHEMATIC AI3495 for Cooking Control operation.

NOTE: If using solid shortening, the control should be programmed to use the melt cycle. In the melt cycle, the control will cycle the heat on/off in short intervals. This will gradually heat and liquify the shortening until it reaches 135°F. Melt cycle default times in seconds are:

Melt Cycle Times	
Liquid	L = 16 on, 18 off
Solid	S = 8 on, 26 off (default for gas)
No Melt	0 = 100% on

On solid state controls only, CY (cycle) is displayed before the shortening letter designation and zero represents no melt.

The control then resumes normal operation as described in this sequence.

1. Conditions.
 - A. Fryer connected to correct supply voltage and properly grounded.
 - B. Gas supply and gas combination valves are on.
 - C. Power switch to the fryer section in the off position.
 - D. Shortening at proper level in fry tank and below last set point temperature.
 - E. Desired shortening selected. (Solid/Liquid)
 - F. Cooking control is setup properly and ready to use.
 - G. Manual drain valve closed (drain valve interlock switch N.O. is closed).
 - H. High limit thermostat closed.
2. Turn power switch on.
 - A. Power to terminal 5 (COM) on left and right basket relays.
 - B. 24VAC transformer energized.
3. Cooking control powers on, initializes and performs a diagnostic self check.

NOTE: If cooking control passes diagnostic self check, the output signals are turned on and operation sequence continues. If cooking control does not pass diagnostic self check, the control displays an error

message for the problem, disables keypad and sounds the electronic alarm continuously. Refer to SOLID STATE CONTROL ALARMS OR COMPUTER CONTROL ALARMS.

4. 24VAC to P5 of interface board.
 5. Control calls for heat.
 - A. 25 VDC to P3 on interface board.
 - B. Triac on interface board supplies 24VAC to ignition module to P6 on interface board.
 6. If shortening temp is below 135°F then melt cycle will operate.
 7. Temperature goes above 135°F and control calls for heat.
 - A. 3 sec prepurge.
 - B. Spark sent to igniters.
 - 7 sec trial for ignition. If flame not detected after 8 sec, Lockout.
- NOTE:** System remains locked out until the power switch is cycled to reset system and restart trial for ignition cycle. (Wait 5 minutes for gas to dissipate)
- 2 sec after flame detected, burner blower motor in low speed and low fire initiated.
 - C. Once burner flame is present, burner blower motor goes from low speed to high speed.
 - D. Ignition module provides ignition status input signal to control.
8. Cooking control evaluates input signals from: Ignition status, drain valve interlock, and temperature probe.
 - A. Ignited burner heats shortening in fry tank.
- NOTE:** As long as the ignition module senses a flame, the internal main voltage (MV) contacts (N.O.) on the ignition module remain closed, and the gas valve stays on.
9. Shortening reaches set temperature.
 - A. Triac on Interface Board de-energized.
 - 1) Gas valve coil de-energized and valve closes.
 - 2) Gas flow stops and burner goes out.
 10. When fryer calls for heat again, ignition sequence will begin at step 5A.
 11. If fryer is left idle, the ignition sequence changes.

12. If shortening is allowed to cool over a long period of time, burner will operate on low heat to maintain shortening temperature near operating temperature.

NOTE: When the fryer shortening is cooling, the controller observes how fast or slow the temperature drops. If the temperature drops slowly the controller will operate the burner with the blower motor in low speed allowing the burner to operate at a lower BTU output to save our customers money by using less gas. The fryer will still reach set temperature, just at a slower pace. If the temperature drops rapidly, the controller will operate the burner blower motor in low speed until the flame is rectified, then it will change to the high speed for the rest of the call for heat

Drawer Filter System

Refer to SCHEMATIC AI3496 for Drawer Filter System operation. Refer to VK OPERATOR MANUAL and DRAWER FILTRATION SYSTEM SUPPLEMENT for specific instructions on filtering.

NOTE: The discard valve handle is connected to a mechanical valve and magnetic reed switch assembly to route the flow of shortening in the filtering system and supply power to the pump motor.

1. Conditions.
 - A. Fryer connected to correct supply voltage and is properly grounded .
 - B. Power switch to fryer section to filter turned on.
 - C. The cooking control should be setup properly and ready to use.
 - D. Cooking control temperature setting between 300°F (minimum) and 350°F (maximum).

NOTE: Shortening should not be filtered outside of this temperature range. At lower temperatures the shortening is thicker which may increase filtering time and place a greater load on the pump. At higher shortening temperatures, oil seal life is decreased.

- E. Filter drawer assembly installed properly.
- F. Drain valve handle (white) retracted.
 - 1) Drain valve interlock switch N.O. contacts open. Mechanical drain valve closed.
2. Allow shortening to cycle between 300°F and 350°F for approximately 10 minutes.

NOTE: If using solid shortening, once it has melted, stir the shortening to eliminate any sold shortening in cold zone of the fry tank.

3. Open drain valve to fryer section in need of filtering and drain shortening into filter tank.
 - A. Display indicates draining.
 - B. Drain valve interlock switch contacts open and position of drain valve is indicated to cooking control.

NOTE: If using solid shortening, allow hot shortening to stand in filter tank for approximately 6 minutes prior to filtering.

4. Press filter key on the control panel and hold for 3 seconds. The filter output signal (24VAC) at pin E1-9 is turned on and the interface board K3 relay coil is energized at pins 11 & 4.
 - A. K3 N.O. contacts close and 24VAC is output from the interface board at pin 12.
 - B. R1 pump motor relay coil (24VAC) is energized and both sets of N.O. contacts close.

NOTE: Jumper wire number 24 connects one set of R1 N.O. contacts to R2 COM.

- 1) Fill solenoid valve is energized (120VAC) thru R2 fill relay N.C. contacts and valve opens.
- 2) Pump motor is energized (120VAC) and pump circulates shortening through filtering system.
5. When filtering is completed, close the drain valve and allow the fry tank to refill.
 - A. Display indicates fill tank.
 - B. Drain valve interlock contacts close and the position of the drain valve is indicated to the cooking control.
6. When all filtered shortening is returned to the fry tank, press filter key on the control panel.
 - A. Power is removed from fill solenoid valve and pump motor.
 - B. Display indicates tank full hit temp. If shortening is at proper level in fry tank, press and hold temp key until shortening temperature is displayed. Filtering cycle is complete and fryer resumes normal operation.

NOTE: If using solid shortening, when all filtered shortening is returned to fry tank and pump motor is off, open filter drawer approximately one inch. Allow remaining shortening in line to drain into filter tank to prevent possible clogging after shortening cools and solidifies. Close filter drawer when complete.

SCHEMATIC DIAGRAMS

ANALOG CONTROLS - NO OPTIONS

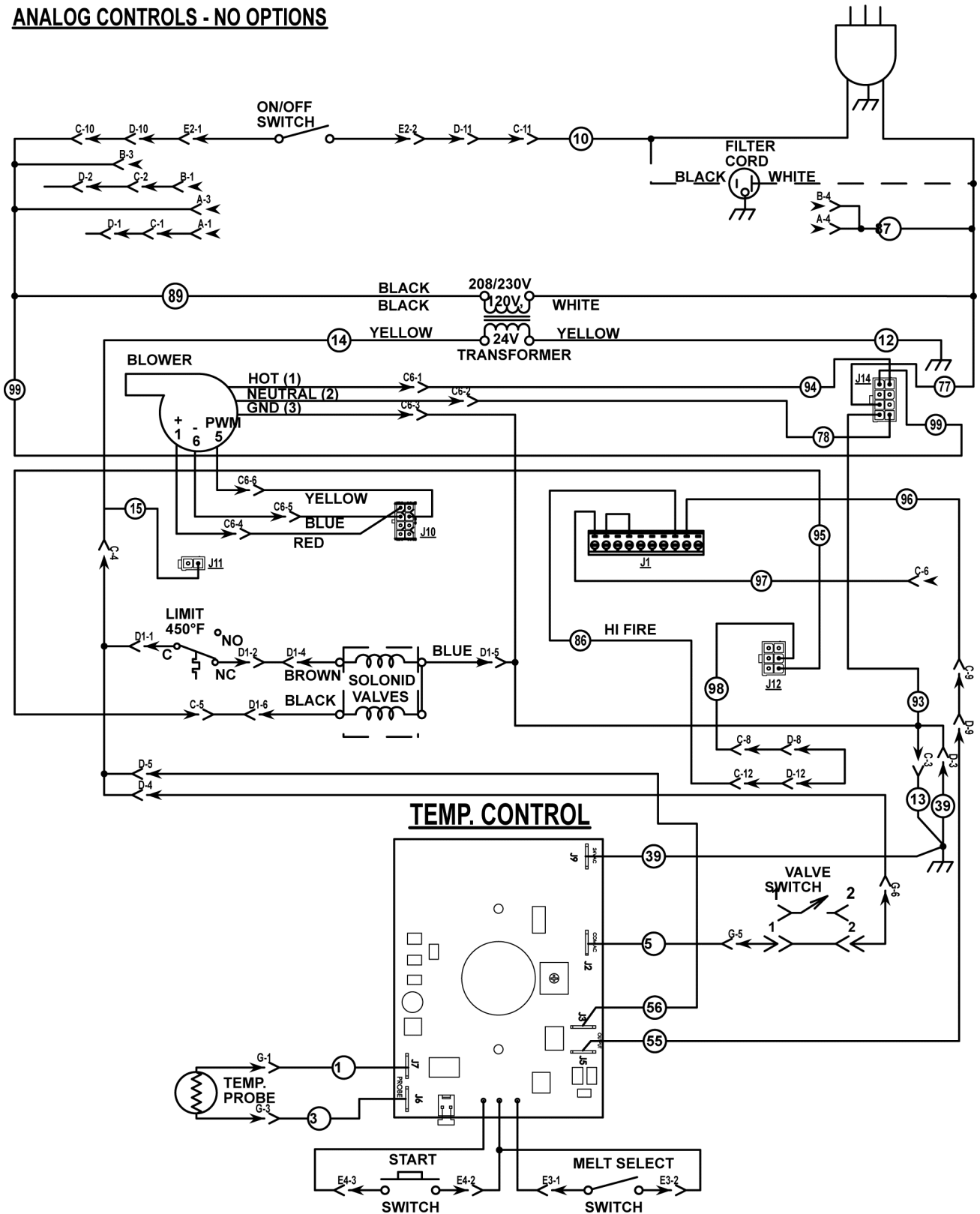

DERIVED FROM 959233-3D

AI3493

Analog Controls - No Options

ANALOG CONTROLS KLEENSCREEN

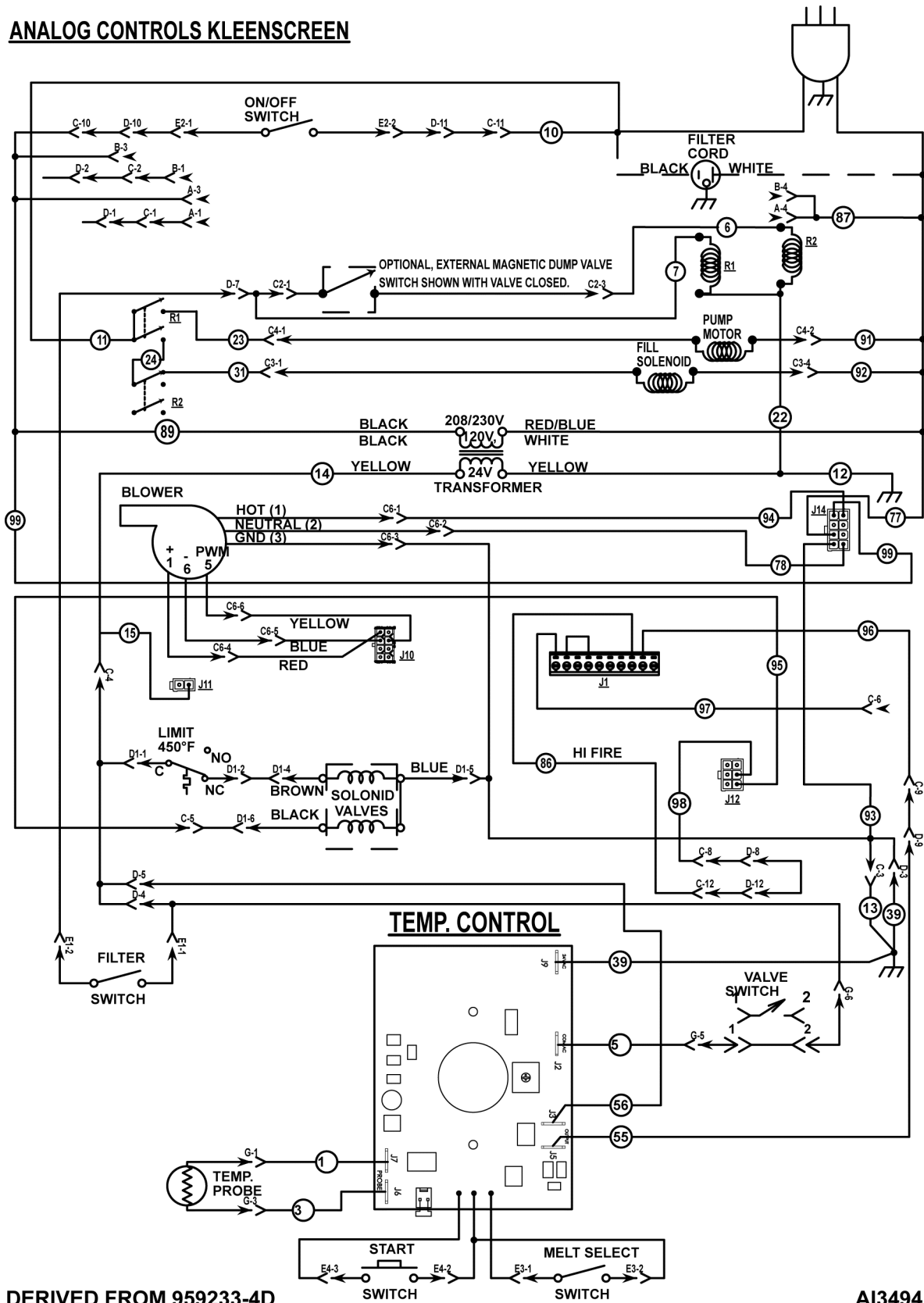

DERIVED FROM 959233-4D

AI3494

Analog Controls - Kleenscreen

SOLID STATE OR COMPUTER CONTROL - NO OPTIONS

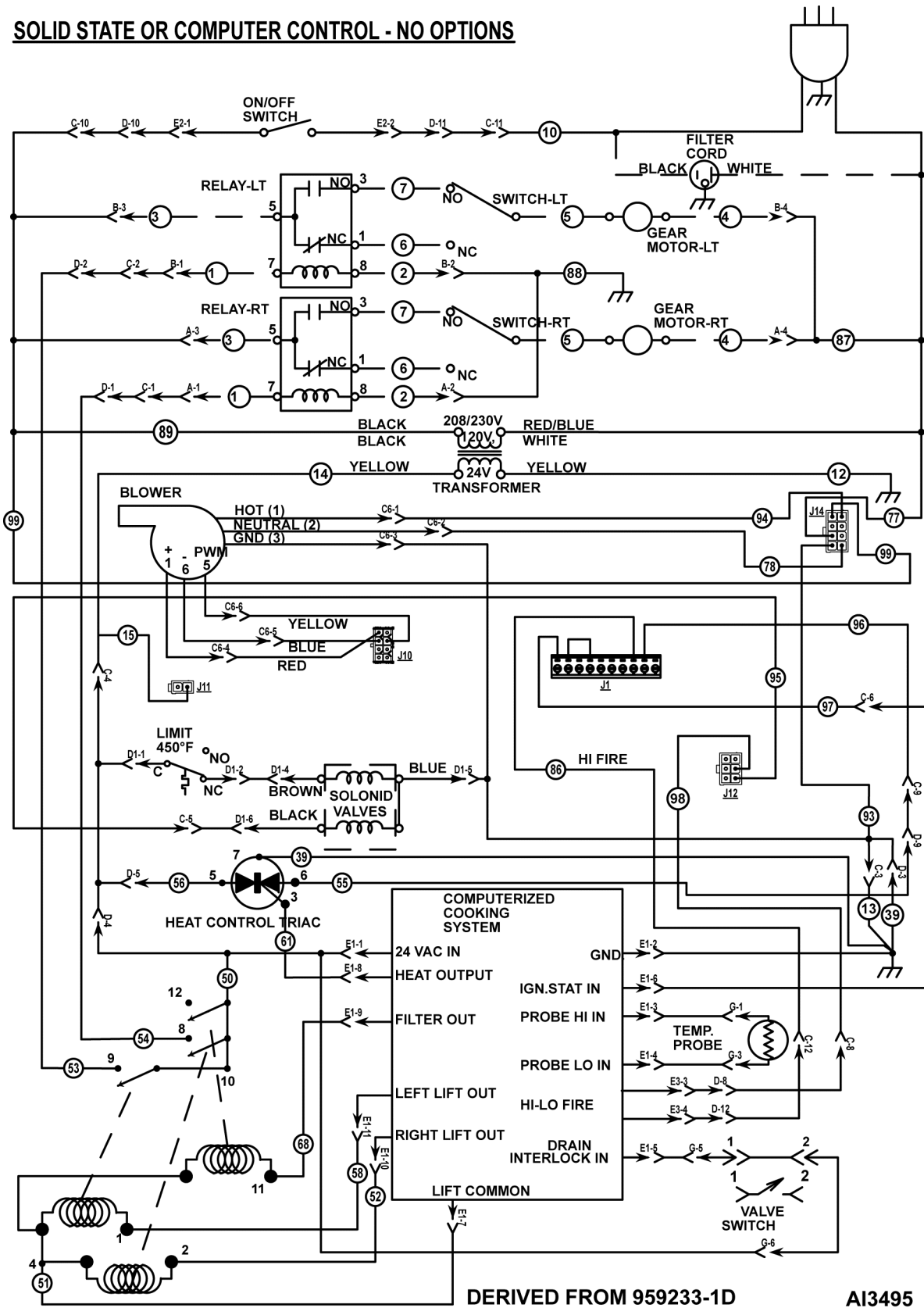

Solid State or Computer Control - No Options

SOLID STATE OR COMPUTER CONTROL KLEENSCREEN

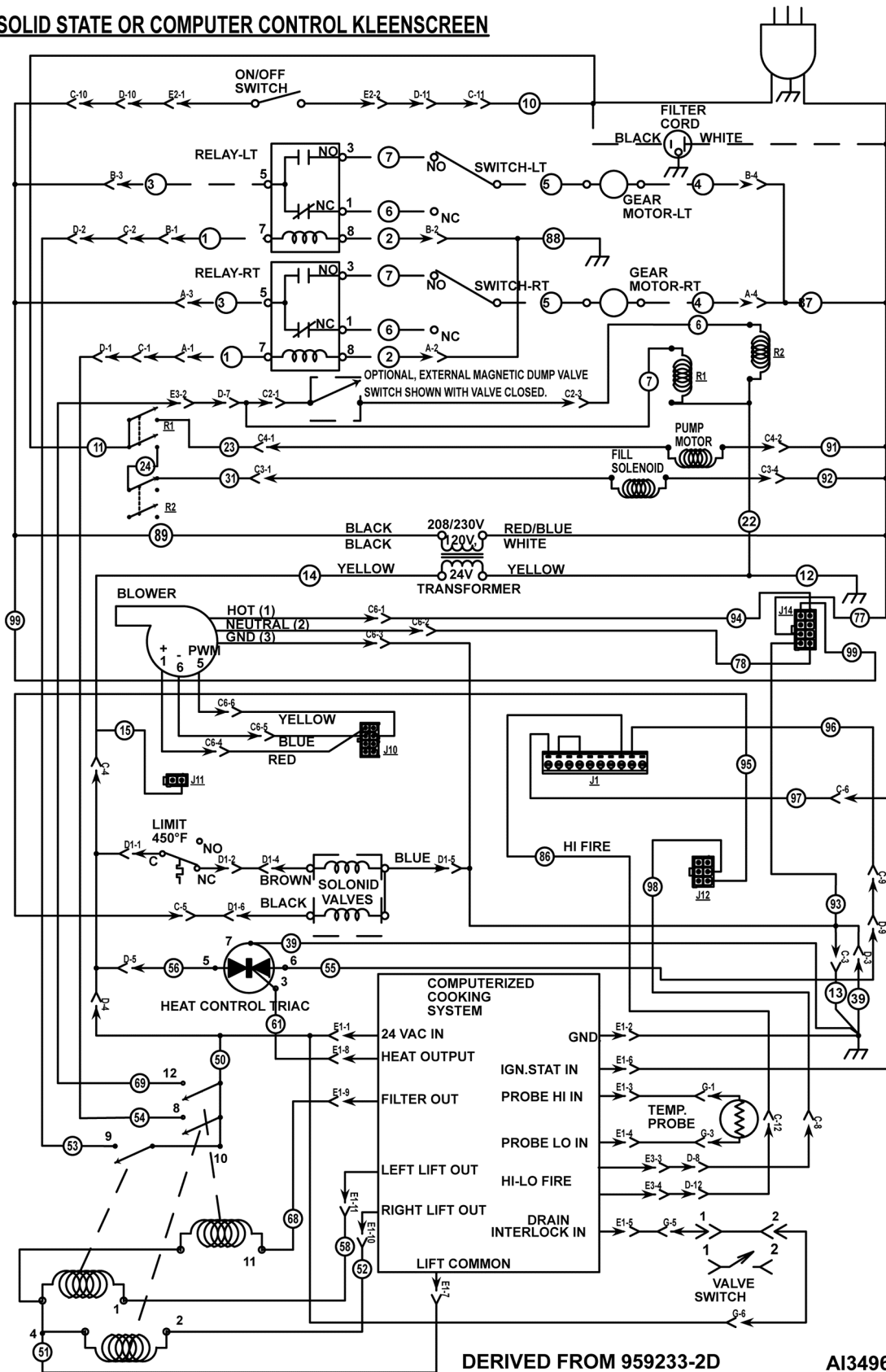

Solid State of Computer Control - KleenScreen

WIRING DIAGRAMS

1	1	Z12	HARNES. BLOWER CONNECTION	958452-G1
1	1	Z3	MAINFOLD HARNES	958453-G1
1	1	M	HARNES. MAIN	958455-G1
1	1	L	H-LIMIT	958475-1
1	1	K	COMBO VALVE	NAT 958045-1 LP 958045-2
1	1	J	INTERFACE HARNES	958035-G1
1	2	G	TERMINAL STATIONARY	419317
1	1	E	CONTROL INTERFACE TRIDELTA	427759-1
1	1	D	D.V.I. HARNES ASSEMBLY	427750-G1
1	1	C	THERMISTOR	958474-1
1	1	B	ROCKER SWITCH ASSEMBLY	427755-G1
1	1	A1	NCC CONTROLLER TIMER(S)	497761-1
1	1	A	NCC COMPUTER	497771-2
REQ	REQ	ID	DESCRIPTION	PART NO.
WIRING INFORMATION				
FOR UNITS LISTED				
VK FRYERS W/ E, L, W & W/ LIFTS				
W & W/ SOLENOID KLEENSCREEN				

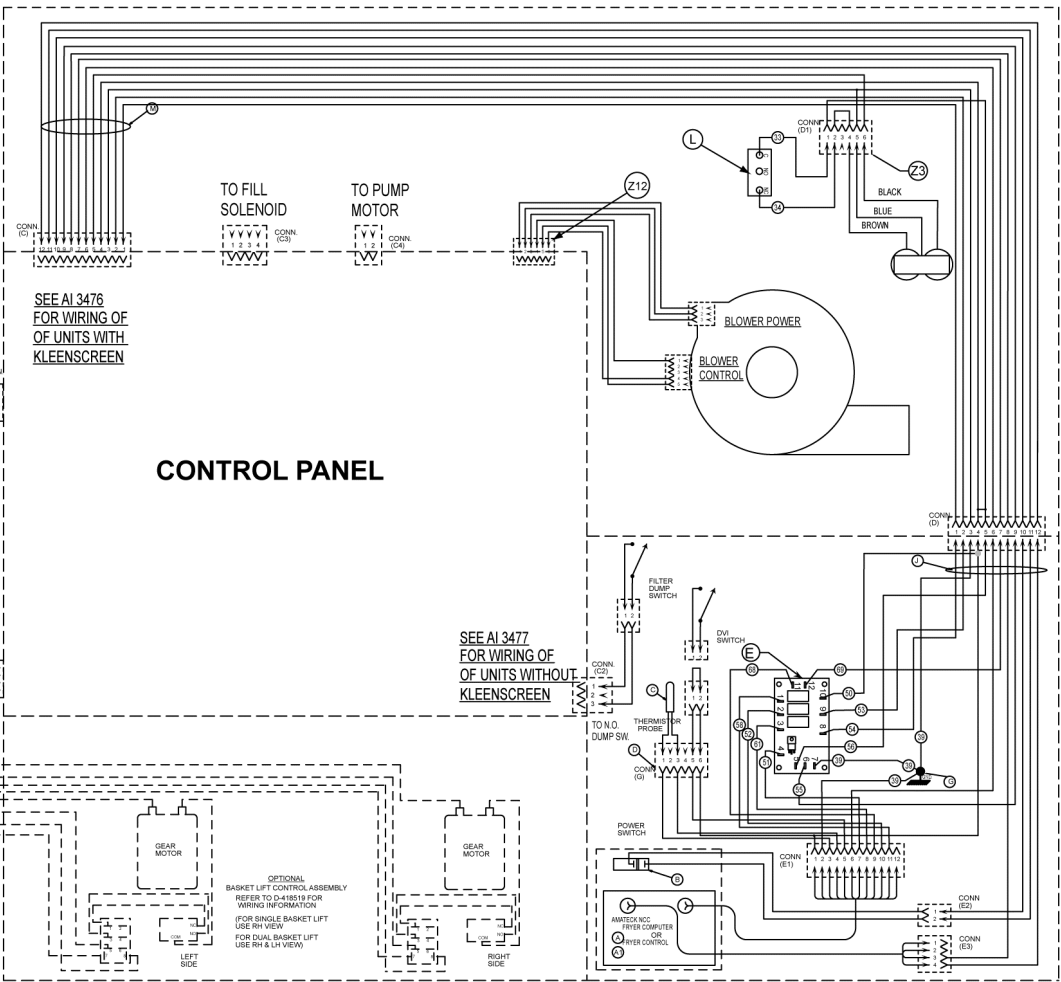

DERIVED FROM 958401-1 REV.K

A13475

VK Fryer (C and D Models)

VK and TR GAS FRYERS W/Wo KleenScreen PLUS - ELECTRICAL OPERATION

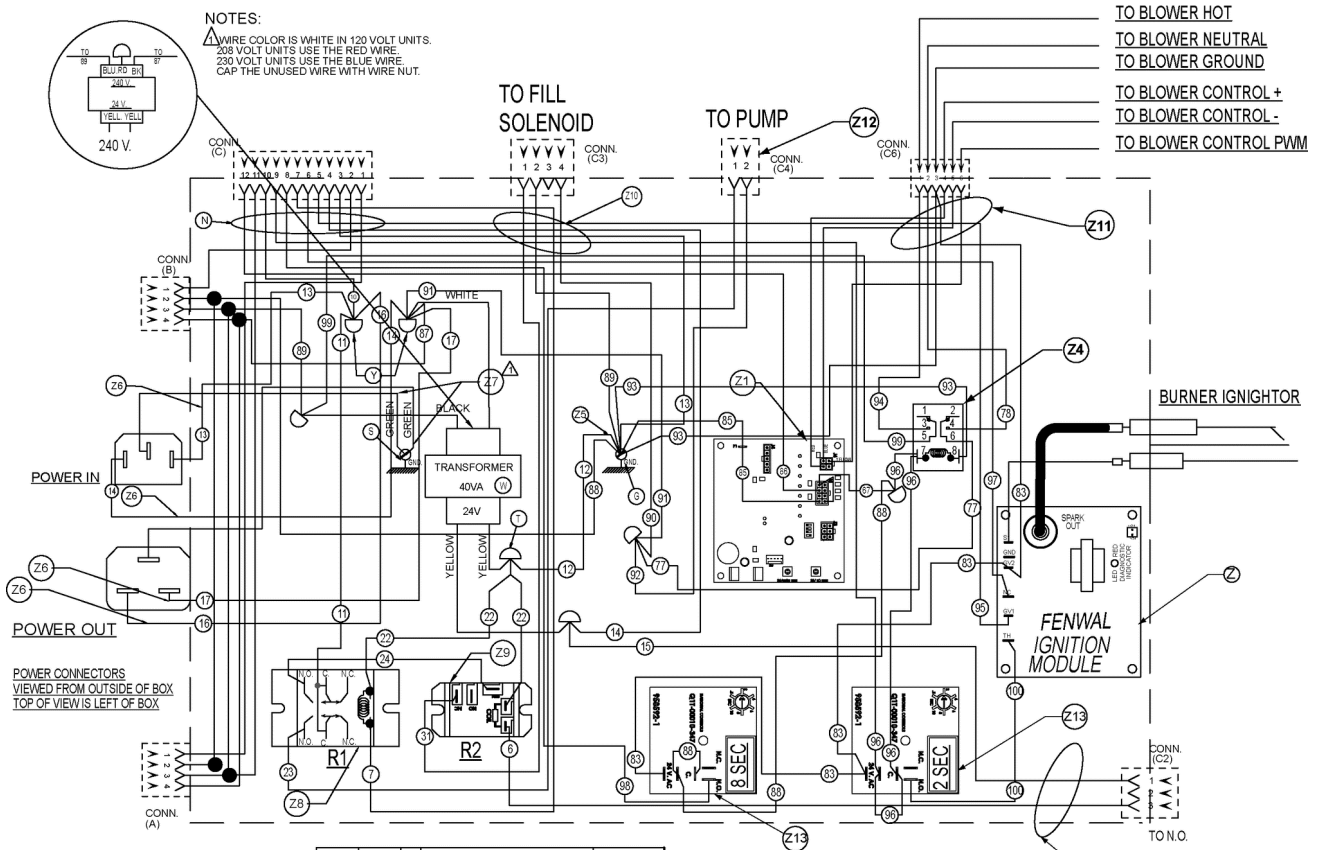

1	1	Z14	HARNES DUMP SWITCH CONNECT	958678-G3
2	2	Z13	TIME DELAY RELAY 24 VAC DRIVE	958590-1
1	1	Z12	HARNES, PUMP MOTOR CONNECT	958678-G2
1	1	Z11	HARNES, BLOWER MOTOR CONTROL	958451-G1
1	1	Z10	HARNES, SOLENOID CONNECT	958678-G1
1	1	Z9	RELAY SPST 24 VAC COIL	467125-1
1	1	Z8	RELAY 1 HP 120 VOLT	428864-1
2	2	Z7	WIRE ASSEMBLY (GREEN)	414715-006IS
4	4	Z6	WIRE ASSEMBLY (13, 14, 16, 17)	414724-006GS
1	1	Z5	WIRE ASSEMBLY (1, 2)	414730-006IS
2	2	Z4	RELAY DPDT 24 VAC COIL	416535-4
1	1	Z1	BOARD, BLOWER CONTROL	958319-1
1	1	Z	CONTROL, SPARK IGNITION	959179-1
2	2	Y	WIRE NUT YELLOW	FE009-32
1	1	W	24V 40VA TRANSFORMER	120 VOLT 340 VOLT 411500-12 411500-13
2	2	T	WIRE NUT	FE006-29
1	1	S	GROUND LUG	417856-1
1	1	P	IGNITER CABLE	423813-5
1	1	N	POWER HARNES	958454-G1
REQ	REQ	IT	DESCRIPTION	PART NO.
VKD MODELS	VKC MODELS	WIRING INFORMATION FOR UNITS LISTED		

WIRING DIAGRAM
W/SOLENOID KLEENSCREEN
VK FRYERS W/E.L. W & WO/LIFTS

DERIVED FROM 958402-1 REV. K

A13476

Power Supply Box (Before 12/1/12) - VK Fryer with basket lifts and Kleenscreen

VK and TR GAS FRYERS W/Wo KleenScreen PLUS - ELECTRICAL OPERATION

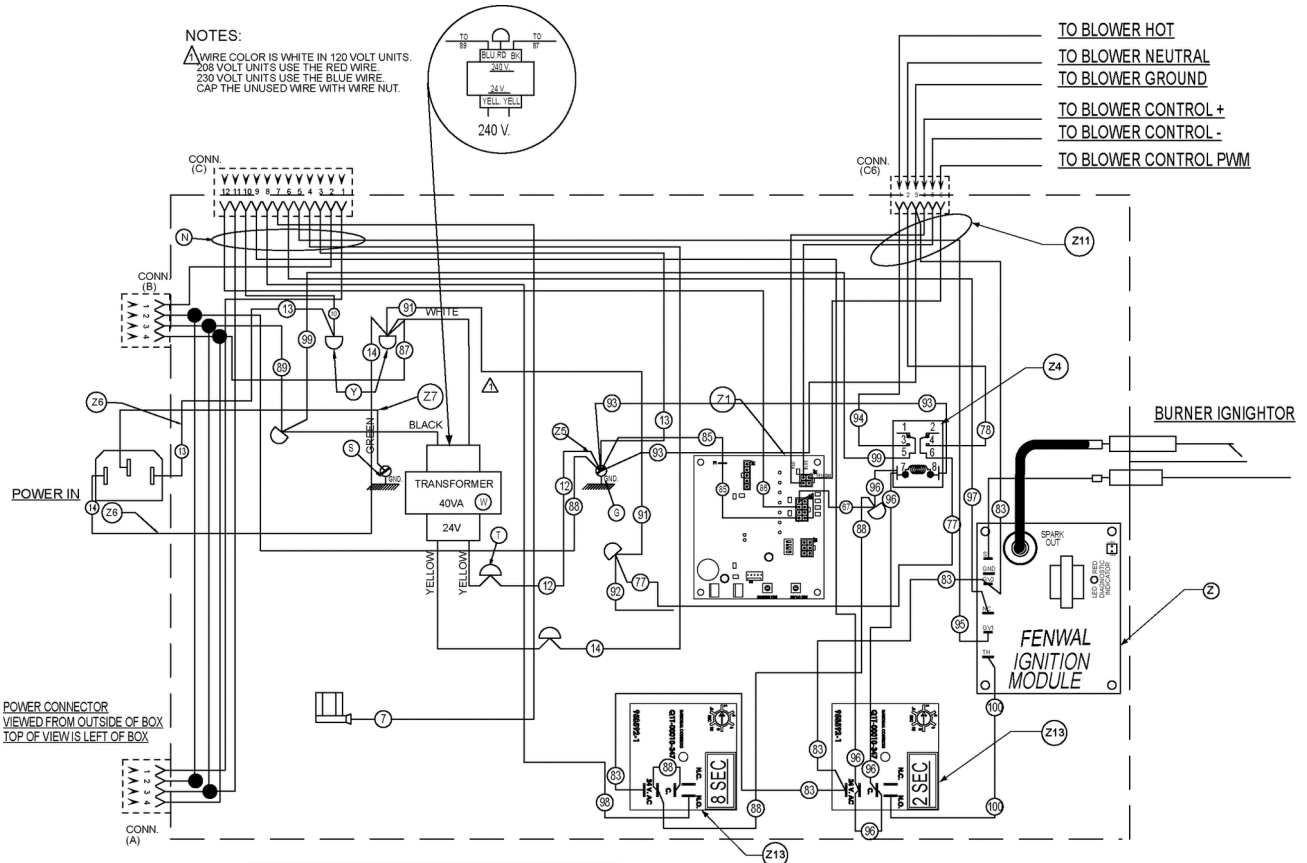

2	2	Z13	TIME DELAY RELAY 24 VAC DRIVE	968592-1
1	1	Z11	HARNES, BLOWER MOTOR CONTROL	968451-G1
1	1	Z7	WIRE ASSEMBLY (GREEN)	414715-006IS
2	2	Z8	WIRE ASSEMBLY [13,14]	414724-006GS
1	1	Z5	WIRE ASSEMBLY [12]	414730-006IS
2	2	Z4	RELAY DPDT 24 VAC COIL	416535-4
1	1	Z1	BOARD, BLOWER CONTROL	968319-1
1	1	Z	CONTROL, SPARK IGNITION	969179-1
2	2	Y	WIRE NUT YELLOW	FE009-32
1	1	W	24V 40VA TRANSFORMER 120 VOLT	411500-12
2	2	T	WIRE NUT	FE009-29
1	1	S	GROUND LUG	417856-1
1	1	P	IGNITER CABLE	423813-5
1	1	N	POWER HARNES	968454-G1
REQ.	REQ.	IT	DESCRIPTION	PART NO.
VKD MODELS	VKC MODELS		WIRING INFORMATION	
			FOR UNITS LISTED	

WIRING DIAGRAM WO/SOLENOID KLEENSCREEN
 VK FRYERS W/E.I. W & WO/LIFTS

DERIVED FROM 958402-1 REV. K

AI 3477

Power Supply Box (Before 12/1/12) - VK Fryer without basket lifts and Kleenscreen

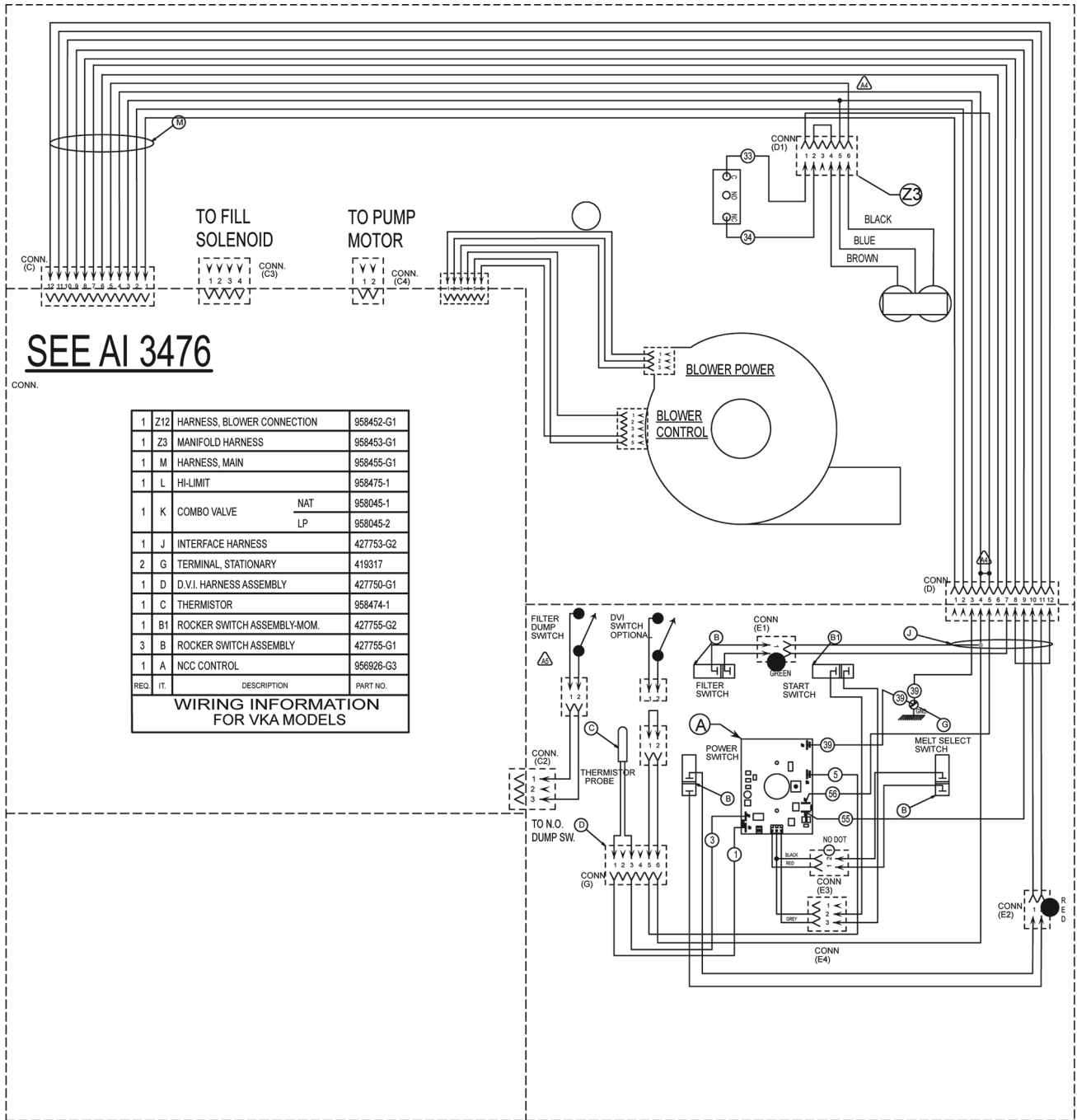

WIRING DIAGRAM ANALOG - WITH KLEENSCREEN

DERIVED FROM 958402-2 REV. E

AI 3478

VK Fryers with Electronic Ignition and Analog Control and KleenScreen

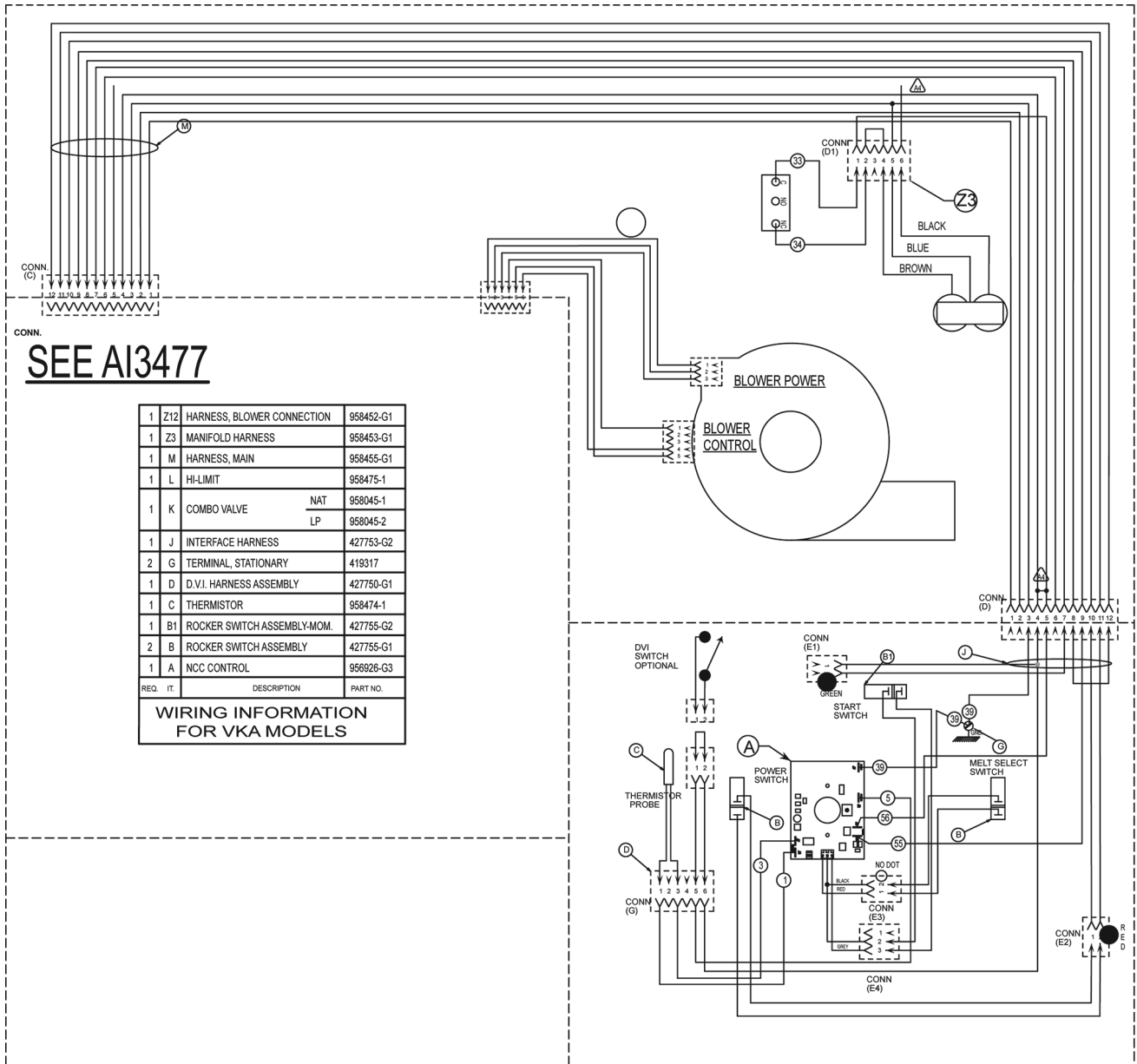

WIRING DIAGRAM ANALOG CONTROL - NO OPTIONS

DERIVED FROM 958402-3 REV E

AI 3479

VK Fryers with Electronic Ignition and Analog Control

[VK/TR D & C Fryer Wiring Diagram](#)

[VK/TR Analog Control W/ Kleenscreen Fryer Wiring Diagram](#)

[VK/TR Analog Control W/E.I. Stand Alone Fryer Wiring Diagram](#)

TROUBLESHOOTING

TROUBLESHOOTING

ALL MODELS	
SYMPTOMS	POSSIBLE CAUSES
Ignition lockout, continuous loud beep	<ol style="list-style-type: none"> 1. Harness connection to gas valve. 2. Gas valve or gas pressure. 3. Air filter. 4. All harness connections. 5. Electrode. 6. Drain valve switch open or switch malfunction. 7. Interconnecting wiring malfunction. 8. Ignition module malfunction. 9. High limit or thermostat open. 10. Vent hose closed off or restricted.
Initial beep then shut off	<ol style="list-style-type: none"> 1. Grounding status. 2. Check electrode.
No spark no blower	<ol style="list-style-type: none"> 1. Harness connections (check for flashing light in A control). 2. Probe lead wires. 3. Open probe. 4. Controller. 5. Open fuse on ignition/blower control board
"Puffing" during initial start up	<ol style="list-style-type: none"> 1. Air Filter dirty. 2. Incorrect gas pressure. 3. Vent hose closed off or restricted. 4. Cracked electrode. 5. Electrode gap exceeding 3/16".
Burner lights but will not maintain flame	<ol style="list-style-type: none"> 1. Igniter/flame sense misaligned. 2. Insufficient gas pressure. 3. Incorrect polarity from transformer to ignition module.

ALL MODELS	
SYMPTOMS	POSSIBLE CAUSES
Excessive heat	<ol style="list-style-type: none"> 1. Incorrect temperature offset selected. 2. Set temperature exceeding 400°F. 3. Temperature probe malfunction. 4. Cooking control malfunction. 5. Interface board malfunction. 6. Gas pressure incorrect.
Low heat	<ol style="list-style-type: none"> 1. Incorrect temperature offset selected. 2. Cooking control malfunction. 3. Temperature probe malfunction. 4. High limit tripped. 5. Interface board malfunction. 6. Gas pressure incorrect.
Intermittent problems	<ol style="list-style-type: none"> 1. High ambient temperatures. 2. Wiring connections loose.
No power to cooking control, fryer does not heat	<ol style="list-style-type: none"> 1. Power switch off or malfunction. 2. Main circuit breaker off. 3. Transformer inoperative. 4. Interconnecting wiring malfunction.
High limit thermostat shutting down system	<ol style="list-style-type: none"> 1. Shortening level below minimum fill line. 2. Probe malfunction. 3. Control malfunction.
Excessive time to melt shortening (more than 45 minutes)	<ol style="list-style-type: none"> 1. Melt cycle timing incorrect. 2. Insufficient gas pressure. 3. Air inlet obstructed or incorrect. 4. Probe malfunction. 5. Control malfunction.
Dry fire fry tank	<ol style="list-style-type: none"> 1. Magnets on drain valve (DVI switch) not aligned properly. 2. Control malfunction. 3. Probe malfunction.